

NEW PRODUCT GUIDE

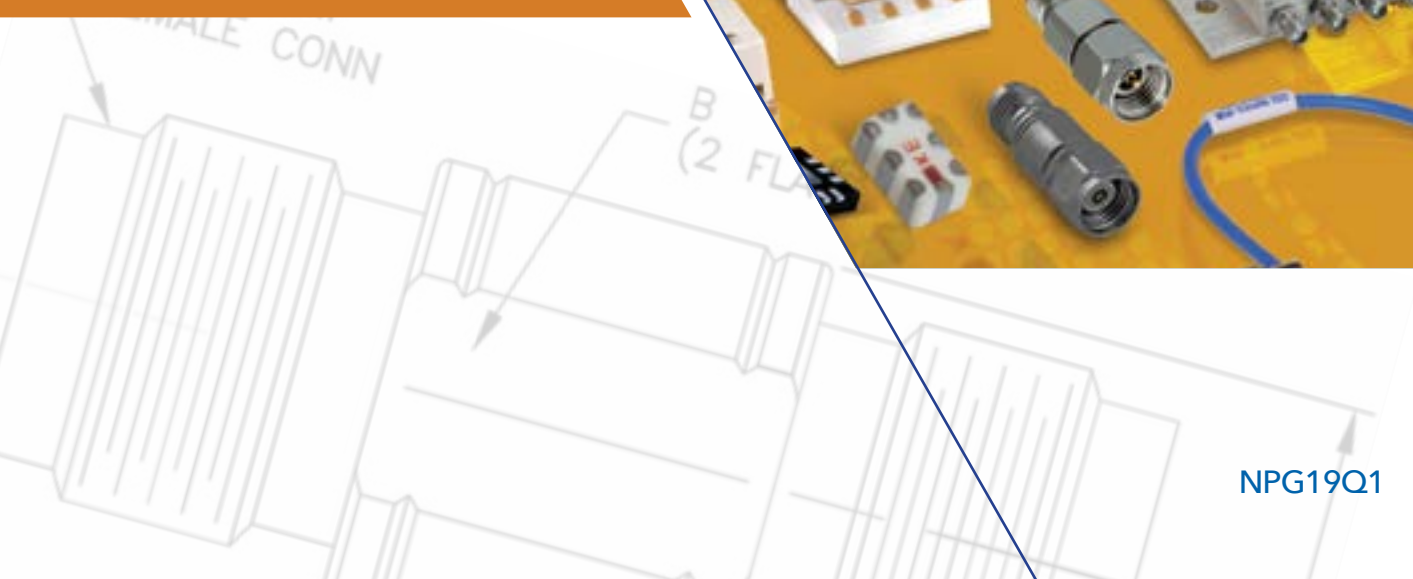



TABLE OF CONTENTS

4	AMPLIFIERS
8	ATTENUATORS
10	BIAS TEES
12	CABLES
14	COUPLERS
18	DC BLOCKS
20	EQUALIZERS
28	FILTERS
32	SPLITTERS/COMBINERS/HYBRIDS
36	SWITCHES
42	TEST SOLUTIONS
44	TRANSFORMERS & BALUNS
46	VCOS

AMPLIFIERS



H I G H L I G H T S

- Hi-Rel Ceramic MMIC LNAs
- Wideband Power Amplifier Modules, 25 - 100W
- New MMIC designs

50Ω DC - 8000 MHz

HI-REL Ceramic MMIC Amplifiers

- Ceramic, hermetically sealed, nitrogen filled
- Low profile case, 0.045"
- Tested to meet MIL requirements
- Operating temperature from -40°C to 125°C
- Available for space level screening



Model Number	Frequency Range (MHz)	Gain (dB) Typ.	NF (dB) Typ.	P1dB (dBm) Typ.	OIP3 (dBm) Typ.	Input VSWR (:1) Typ.	Output VSWR (:1) Typ.	Voltage (V)	Current (mA)
CMA-62+	10-6000	15.4	5.1	19.2	33	1.5	1.8	5	82
CMA-63+	10-6000	20.3	3.9	18.4	32	1.1	1.4	5	69
CMA-81+	DC-6000	10	7.4	19.6	34	1.3	1.6	5	103
CMA-82+	DC-7000	14.1	6.7	20.6	36.4	1.4	1.9	5	106
NEW! CMA-83LN+	500-8000	21.5	1.3	20.3	30.1	1.32	1.31	5.0/6.0	50/62
CMA-84+	DC-7000	20.2	5.5	21	34.5	1.4	3	5	108
NEW! CMA-103+	50-4000	11	0.8	23.1	44.8	1.38	1.36	5.0/6.0	60/97
CMA-162LN+	7001-6000	23.2	0.49	19.9	30.3	1.4	1.2	4	55
CMA-252LN+	1500-2500	16.8	1	17.8	30	1.5	1.3	4	57
CMA-545+	50-6000	14.2	0.8	20	35	2.3	1.5	3	80
CMA-545G1+	400-2200	31.8	0.9	23.3	36.5	1.9	1.4	5	158
CMA-5043+	50-4000	18.4	0.75	19.8	33.5	1.7	1.5	5	58

CMA-83LN+

GAIN VARIATION vs. FREQUENCY & TEMPERATURE
INPUT POWER = -25.00dBm, Vd = 6.00V

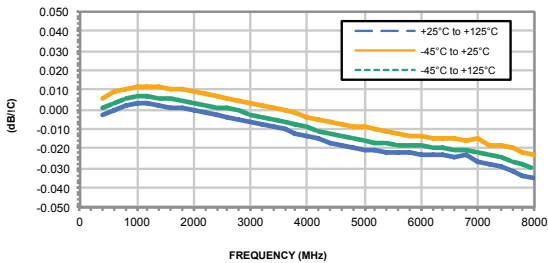

OUTPUT IP3 vs. FREQUENCY & DEVICE VOLTAGE
OUTPUT POWER = 0.00dBm, Temperature = +25°C

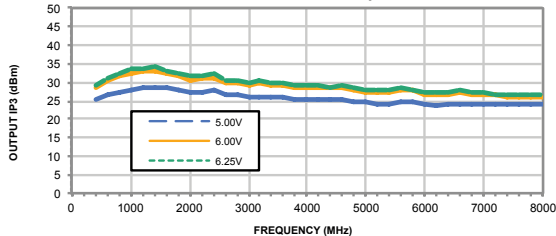

NOISE FIGURE vs. FREQUENCY & DEVICE VOLTAGE
Temperature = +25°C

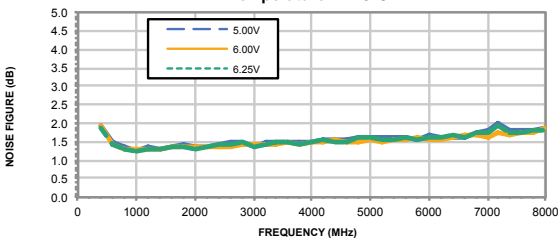

CMA-103+

GAIN VARIATION vs. FREQUENCY & TEMPERATURE
INPUT POWER = -25.00dBm, Vd = 5.00V

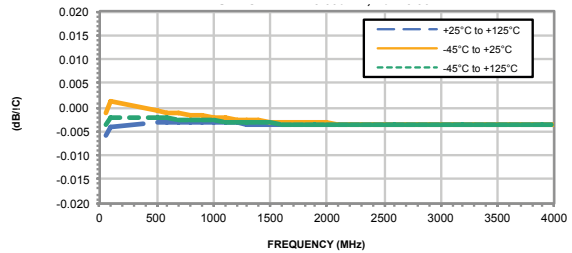

OUTPUT IP3 vs. FREQUENCY & TEMPERATURE
OUTPUT POWER = 5.00dBm, Vd = 5.00V

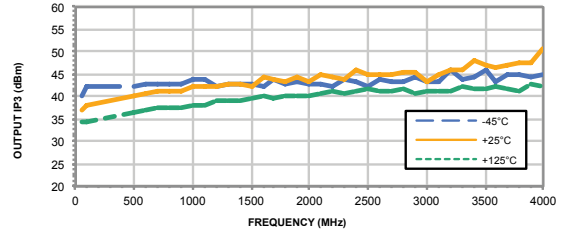

NOISE FIGURE vs. FREQUENCY & DEVICE VOLTAGE
Vd = 5.00V

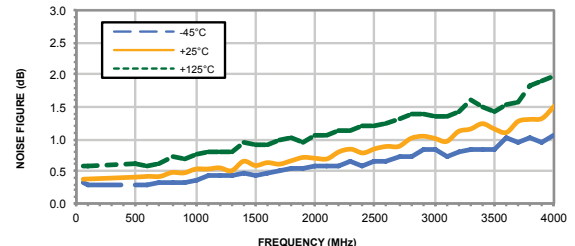

50Ω up to 100W 20 to 6000 MHz

Coaxial High Power Amplifiers

- Wide bandwidth spanning 20 to 6000 MHz
- High gain, up to 59 dB typ.
- Unconditionally stable
- Built-in protections



Model Number	Frequency Range (MHz)	Gain (dB) Typ.	NF (dB) Typ.	P1dB (dBm) Typ.	OIP3 (dBm) Typ.	Input VSWR (:1) Typ.	Output VSWR (:1) Typ.	Voltage (V)	Current (mA)
ZHL-100W-382A+	3300-3850	47	9.5	50	58	1.3	1.3	28	18000
ZHL-100W-272+	700-2700	48	8.2	49	50	1.5	1.5	30	16000
ZHL-50W-63+	700-6000	59	11	42	53	1.5	1.5	40	6000
ZHL-25W-272+	20-2700	50	10	40	49	2	3.5	28	3700

**ZHL-50W-63+
OUTPUT POWER**

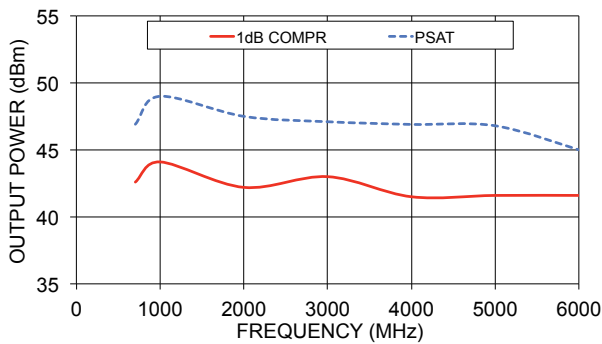

**ZHL-100W-382+
OUTPUT POWER**

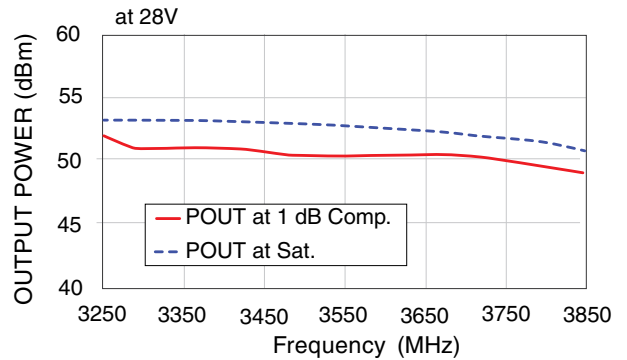

**ZHL-50W-63+
GAIN**

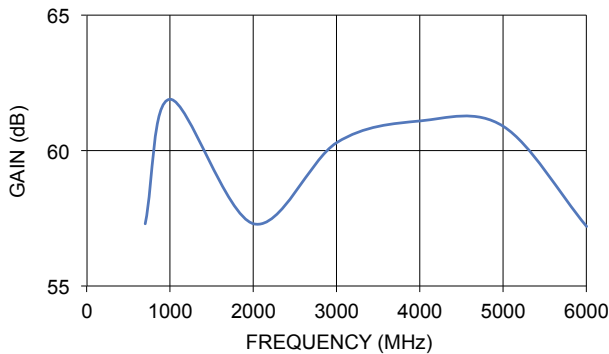

**ZHL-100W-382+
GAIN**

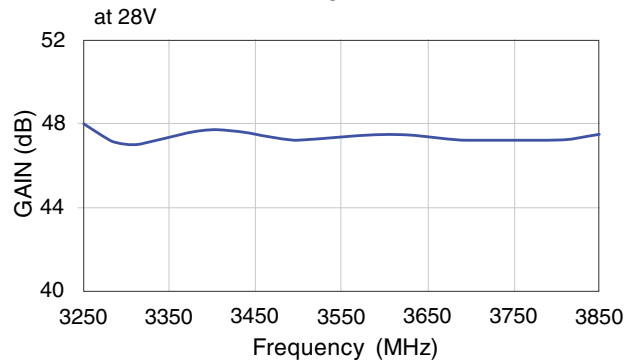

50Ω DC to 20 GHz

Ultra-Wideband MMIC Amplifiers

- Ultra-wide bandwidths with flat gain (EHA)
- High gain with high IP3 (LHY)



Model Number	Frequency Range (GHz)	Gain (dB) Typ.	NF (dB) Typ.	P1dB (dBm) Typ.	OIP3 (dBm) Typ.	Input VSWR (:1) Typ.	Output VSWR (:1) Typ.	Voltage (V)	Current (mA)	Package
EHA-163L+	DC-16	15.3	5.2	6.5	15.6	1.67	1.57	5	20.9	2x2mm 6L MCLP
EHA-24L-D+	DC-20	13.4	5.1	6.8	16.6	1.433	1.377	5	19.1	Die
LHY-84+	DC-7	20	5.4	21	33.1	1.43	2.1	5	111	2x2mm 6L MCLP

50Ω DC to 5.2 GHz

Dual Matched MMIC Amplifier

- Gain, 14.1 dB typ. at 2 GHz
- Dual matched amplifier for push-pull & balanced amplifiers
- High dynamic range



Model Number	Frequency Range (GHz)	Gain (dB) Typ.	NF (dB) Typ.	P1dB (dBm) Typ.	OIP3 (dBm) Typ.	Input VSWR (:1) Typ.	Output VSWR (:1) Typ.	Voltage (V)	Current (mA)	Package
MGVA-82+	DC-5.2	14.1	7	20.2	36	1.3	1.7	5	100	3.5 x 2.5 mm 16L MCLP

Simplified schematic (each of A1, A2) and pad description

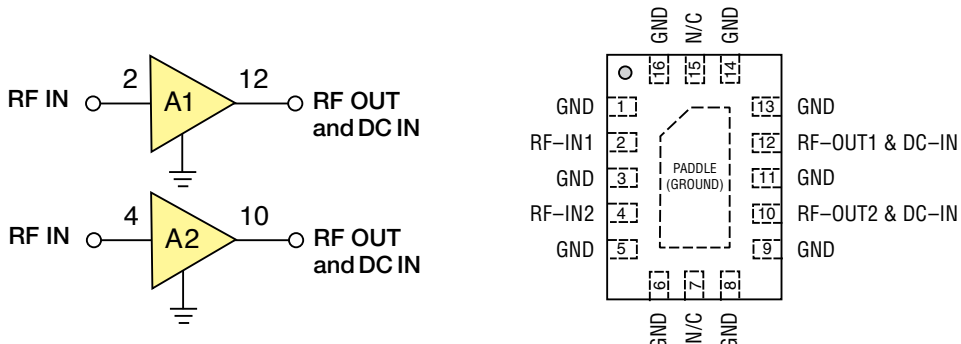

ATTENUATORS



H I G H L I G H T S

- Precision Fixed Models up to 40 and 65 GHz
- Digital Step Attenuators, DC-4000 MHz, 0.5 to 31.5 dB



50Ω DC to 65 GHz

Precision Fixed Attenuators, 1.85mm

Mode Number	Frequency Range (GHz)	Nom. Attenuation (dB)	Attenuation Accuracy (dB)	VSWR (:1), GHz, Max.			Power (W)
				DC-26.5	26.5-50	50-65	
BW-E3-1W653+	DC-65	3	±1.5	1.35	1.55	1.65	1
BW-E6-1W653+	DC-65	6	±1.5	1.35	1.55	1.65	1
BW-E10-1W653+	DC-65	10	±1.5	1.35	1.55	1.65	1
BW-E20-1W653+	DC-65	20	±1.5	1.35	1.55	1.65	1



50Ω DC to 40 GHz

Precision Fixed Attenuators, 2.92mm

Mode Number	Frequency Range (GHz)	Nom. Attenuation (dB)	Attenuation Accuracy (dB)	VSWR (:1), GHz, Max.			Power (W)
				DC-18	18-26.5	26.5-40	
BW-K2-2W44+	DC-40	2	±0.80	1.3	1.4	1.5	2
BW-K3-2W44+	DC-40	3	±0.80	1.3	1.4	1.5	2
BW-K4-2W44+	DC-40	4	±0.80	1.3	1.4	1.5	2
BW-K5-2W44+	DC-40	5	±0.80	1.3	1.4	1.5	2
BW-K6-2W44+	DC-40	6	±0.80	1.3	1.4	1.5	2
BW-K10-2W44+	DC-40	10	±1.0	1.3	1.4	1.5	2
BW-K20-2W44+	DC-40	20	±1.0	1.3	1.4	1.5	2
BW-KM3-2W44+	DC-40	3	±0.40	1.1	1.1	1.2	2
BW-KM6-2W44+	DC-40	6	±0.50	1.1	1.1	1.1	2
BW-KM10-2W44+	DC-40	10	±0.40	1	1.1	1.1	2
BW-KM20-2W44+	DC-40	20	±0.10	1.1	1.1	1.1	2

50Ω DC to 4 GHz

Wide-Band Digital Step Attenuators

- Wideband, operate up to 4 GHz
- Immune to latchup
- High IP3, 52 dBm
- SPI, serial control



Model Number	Frequency Range (GHz)	Attenuation (dB)	Attenuation Step (dB)	IP3 (dBm) Typ.	Power Supply (Vdd)	Dual Power Supply (Vdd, Vss)	Input Power @ 0.2 dB Compr. (dBm) Typ.
ZX76-15R5A-PN+	DC-4	15.5	0.5	52	3V	3V, -3.3V	24
ZX76-31A-PN+	DC-4	31	1	52	3V	3V, -3.3V	24
ZX76-31R5A-PN+	DC-4	31.5	0.5	52	3V	3V, -3.3V	24
ZX76-31R5A-SP+	DC-4	31.5	0.5	52	3V	-	24

BIAS TEES



H I G H L I G H T S

- Ultra-Wideband Surface Mount Models up to 12 GHz

50Ω Wideband 10 MHz to 12 GHz
Surface Mount Bias Tees

- DC current up to 500mA
- Very good insertion loss, as low as 0.3 dB typ.



Model Number	F Low (MHz)	F High (MHz)	Insertion Loss (dB) Typ.	Input Current (mA) Max.	DC port Isolation (dB) Typ.	VSWR (:1) Typ.
NEW! RCBT-63+	10	6000	1	500	20	1.25
TCBT-123+	10	12000	0.3	200	33	1.2
TCBT-14+	10	10000	0.35	200	33	1.2
TCBT-6G+	50	6000	0.7	200	28	1.1

RCBT-63+

INSERTION LOSS
 (0 mA, RF & DC-RF)

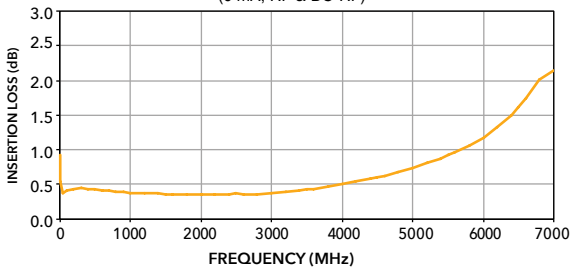

ISOLATION
 (0 mA, RF & DC-DC)

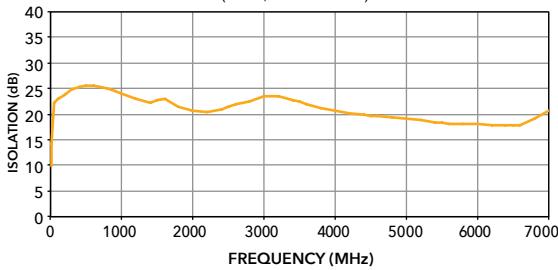

VSWR
 (0 mA, RF & DC)

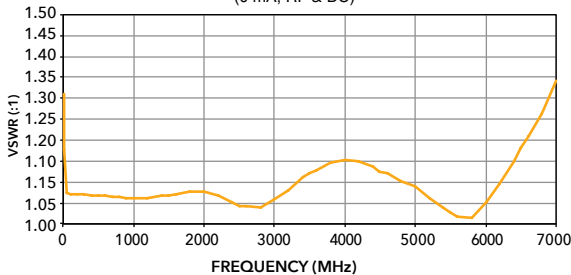

TCBT-123+

INSERTION LOSS

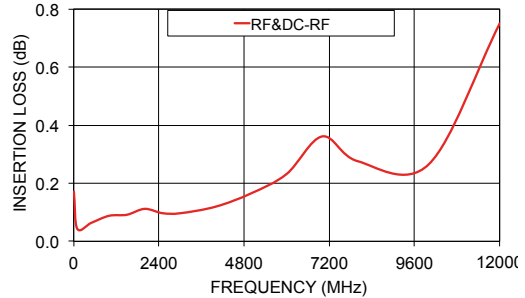

ISOLATION

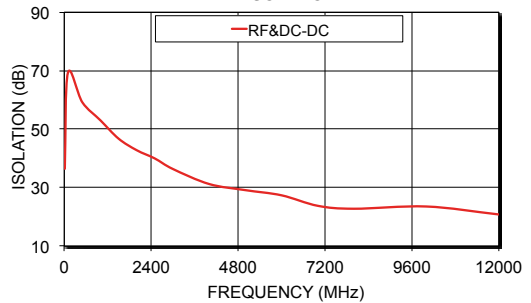

VSWR

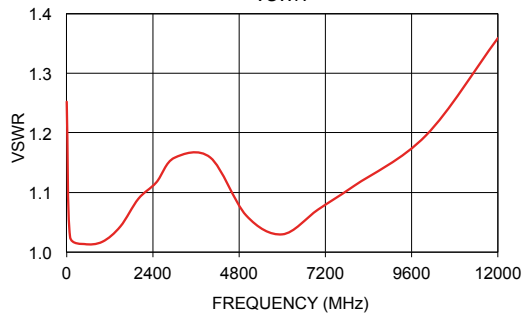

CABLES



H I G H L I G H T S

- HandFlex Interconnect Cables Now Include More Options to Meet Your Needs
- Additional Lengths up to 72"
- New Connector Configurations

50Ω **NOW!** DC to 40 GHz

HAND FLEX™ Coaxial Interconnect Cables

- Hand formable
- 0.086" center diameter
- Tight bend-radius, 6mm
- New lengths



Model Number	Frequency High (GHz)	Insertion Loss (dB)	Length (in)	Connector 1 Type	Connector 1 Gender	Connector 1 Orientation	Connector 2 Type	Connector 2 Gender	Connector 2 Orientation
086-4KM+	40.0	0.6	4.0	2.92 mm	Male	Straight	2.92 mm	Male	Straight
086-9KM+	40.0	1.4	9.0	2.92 mm	Male	Straight	2.92 mm	Male	Straight
086-15KM+	40.0	2.2	15.0	2.92 mm	Male	Straight	2.92 mm	Male	Straight
086-18KM+	40.0	2.4	18.0	2.92 mm	Male	Straight	2.92 mm	Male	Straight
086-24KM+	40.0	3.2	24.0	2.92 mm	Male	Straight	2.92 mm	Male	Straight

50Ω DC to 18 GHz

HAND FLEX™ Coaxial Interconnect Cables

- Hand formable
- 0.141" center diameter
- Tight bend radius, 8mm
- New lengths



Model Number	Frequency High (GHz)	Insertion Loss (dB)	Length (in)	Connector 1 Type	Connector 1 Gender	Connector 1 Orientation	Connector 2 Type	Connector 2 Gender	Connector 2 Orientation
141-26SM	18.0	1.2	26.0	SMA	Male	Straight	SMA	Male	Straight
141-32SM+	18.0	1.3	32.0	SMA	Male	Straight	SMA	Male	Straight
141-40SM+	18.0	1.9	40.0	SMA	Male	Straight	SMA	Male	Straight
141-60SM+	18.0	2.5	60.0	SMA	Male	Straight	SMA	Male	Straight
141-72SM+	18.0	3.1	72.0	SMA	Male	Straight	SMA	Male	Straight

50Ω DC to 18 GHz

HAND FLEX™ Coaxial Interconnect Cables

- Hand formable
- 0.141" center diameter
- Tight bend radius, 8mm
- New connector configurations



Model Number	Frequency High (GHz)	Insertion Loss (dB)	Length (in)	Connector 1 Type	Connector 1 Gender	Connector 1 Orientation	Connector 2 Type	Connector 2 Gender	Connector 2 Orientation
141-3SMRC	18.0	0.2	3.0	SMA	Male	Right Angle 180° Clock	SMA	Male	Right Angle 0° Clock
141-24SBSM	18.0	1.1	24.0	SMA	Male	Straight	SMA	Female	Bulkhead
141-3SMR	18.0	0.2	3.0	SMA	Male	Right Angle 0° Clock	SMA	Male	Right Angle 0° Clock
141-14BM+	3.0	0.2	14.0	BNC	Male	Straight	BNC	Male	Straight
141-36SBSMR+	18.0	1.6	36.0	SMA	Male	Right Angle 0° Clock	SMA	Female	Bulkhead
141-10SMRNM+	18.0	0.5	10.0	N-Type	Male	Straight	SMA	Male	Right Angle 0° Clock

COUPLERS



H I G H L I G H T S

- Ultra-Wideband Directional Couplers up to 40 GHz
- 400W Dual-Directional Coupler for VHF/UHF



COUPLERS

50Ω 500-40000 MHz

Ultra-Wideband Directional Couplers

- Ultra wideband, 0.5 to 40 GHz
- Power handling, 15-20W dB
- Coupling flatness to within ±0.4 dB



Model Number	Frequency Range (GHz)	Coupling (dB) Nom.	Mainline Loss (dB) Typ.	Directivity (dB) Typ.	VSWR (:1) Typ.	Power Input Max. (W)
ZCDC10-02263S+	2000-26500	10	0.9	27	1.11	20
ZCDC10-K0244+	2000-40000	10	1.2	23	1.11	15
ZCDC10-K5R44W+	500-40000	10	1.3	23	1.12	15
ZCDC20-02263S+	2000-26500	20	0.5	18	1.33	20

ZCDC10-K5R44W+

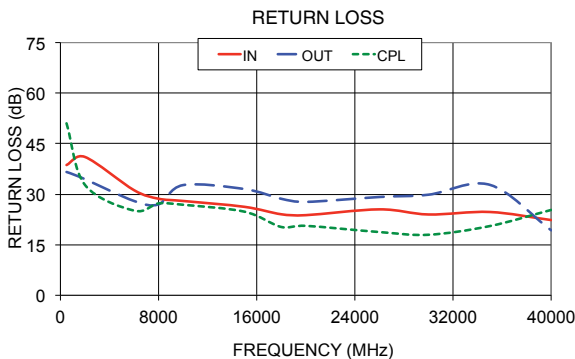
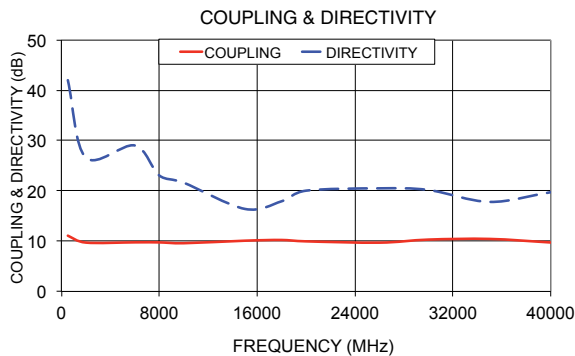
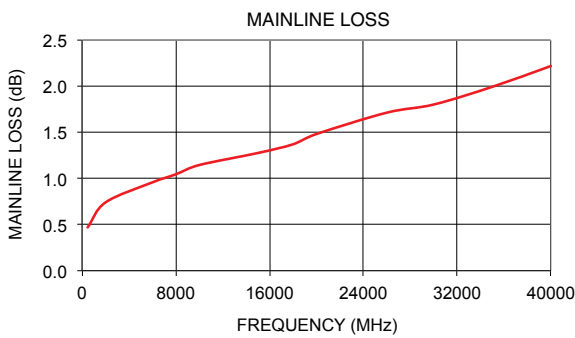

ZCDC10-02263S+

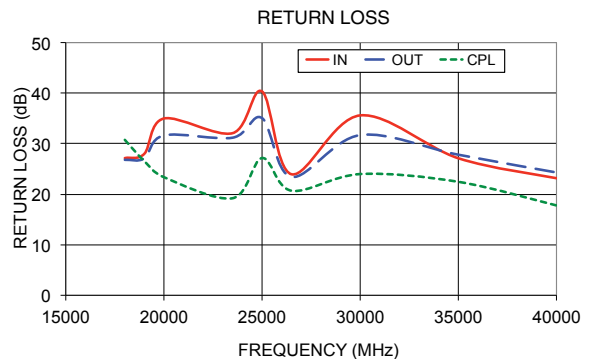
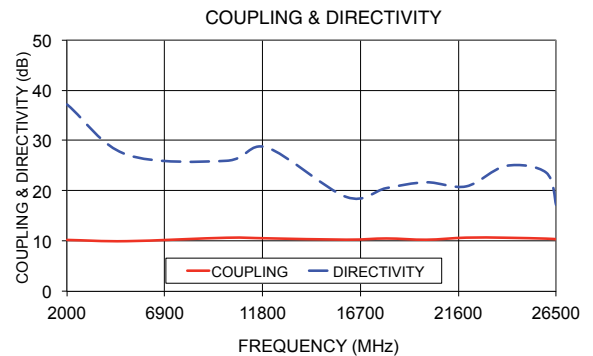
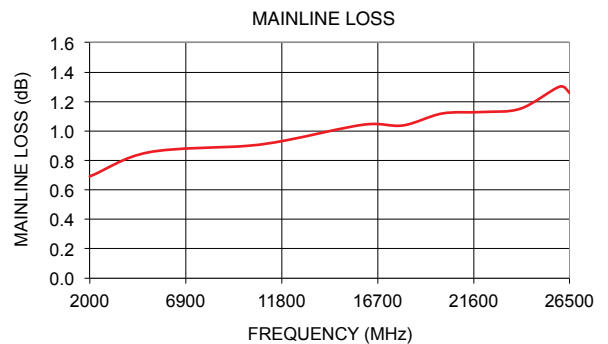

COUPLERS



COUPLERS

50Ω 1800 to 40000 MHz

Wideband Directional Couplers

- 20W power handling
- Insertion loss as low as 0.9 dB
- Good coupling flatness, ±0.5 dB typ.



Model Number	Frequency Range (MHz)	Coupling (dB) Nom.	Mainline Loss (dB) Typ.	Directivity (dB) Typ.	VSWR (:1) Typ.	Power Input Max. (W)	Type
ZDC10-20403-K+	2000-40000	10	1.2	13	1.22	20	Directional
ZDC20-20403-K+	1800-40000	20	0.9	12	1.25	20	Directional

ZDC10-20403-K+

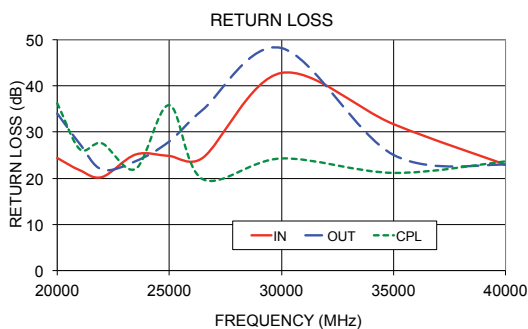
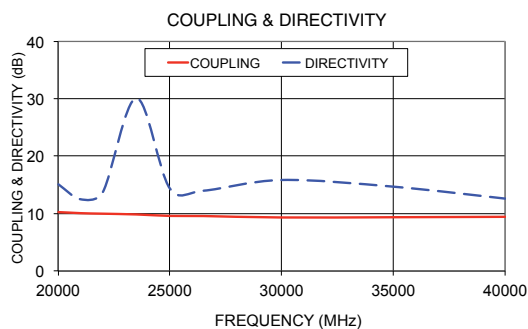

ZDC20-20403-K+

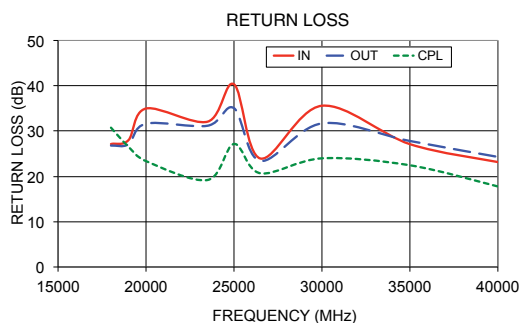
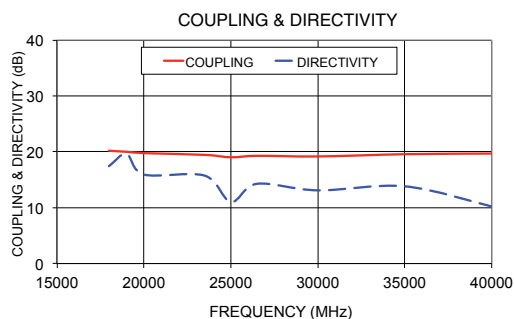
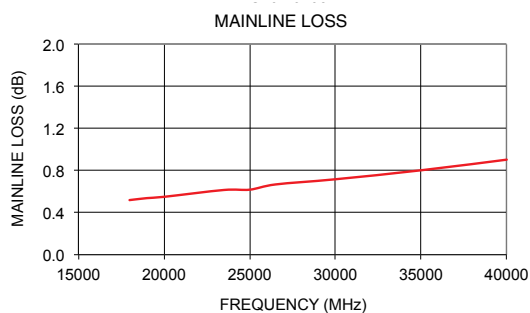

COUPLERS

50Ω 2000 to 18000 MHz

Wideband Directional Coupler

- Excellent coupling flatness, ± 0.4 dB typ.
- 20W power handling



Model Number	Frequency Range (MHz)	Coupling (dB) Nom.	Mainline Loss (dB) Typ.	Directivity (dB) Typ.	VSWR (:1) Typ.	Power Input Max. (W)	Type
ZUDC20-02183+	2000-18000	20	0.5	20	1.22	20	Directional

ZUDC20-02183+

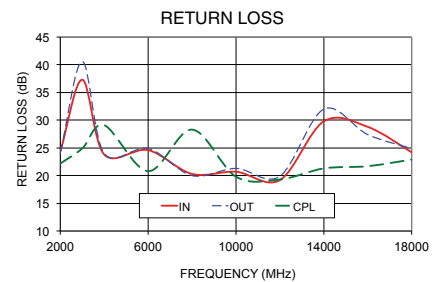
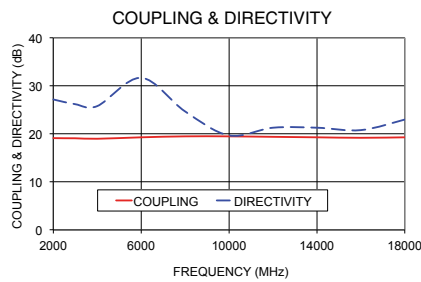
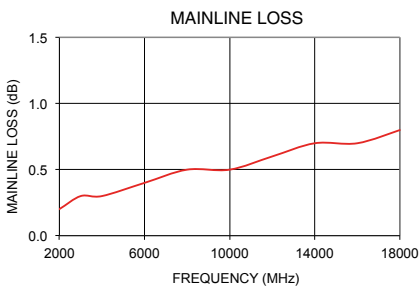

50Ω 20 to 520 MHz

High Power Dual-Directional Coupler

- High power handling, 400W
- Low insertion loss, 0.1 dB Typ.
- Excellent return loss, 28 dB Typ. (In/Out)



Model Number	Frequency Range (MHz)	Coupling (dB) Nom.	Mainline Loss (dB) Typ.	Directivity (dB) Typ.	VSWR (:1) Typ.	Power Input Max. (W)	Type
ZDDC-50-521+	20-520	50	0.05	21	1.05	400	Bi-Directional

ZDDC-50-521+

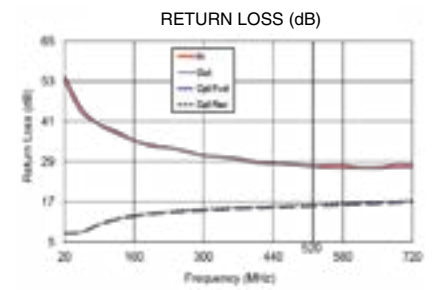
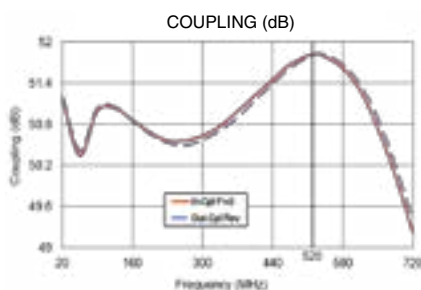
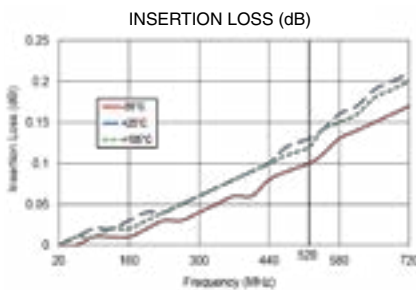

DC BLOCKS



H I G H L I G H T S

- New coaxial models up to 65 GHz
- SMA, 2.92mm, 2.4mm, and 1.85mm connector types now available

50Ω 0.01 to 65 GHz

DC Blocks

- Ultra-broadband performance
- Insertion loss as low as 0.7 dB
- Excellent return loss



Model Number	Frequency Range (GHz)	Insertion Loss (dB) Typ.	Return Loss (dB) Typ.	Connector Type
BLK-18W+	0.01-18	0.41	23	SMA
BLK-K44+	0.01-40	0.43	25	2.92mm
BLK-V54+	0.01-50	0.51	23	2.4mm
BLK-E653+	0.01-65	0.7	22	1.85mm

BLK-18W+

Insertion Loss

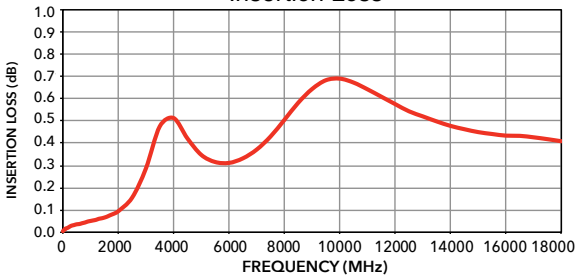

SMA-Female Return Loss

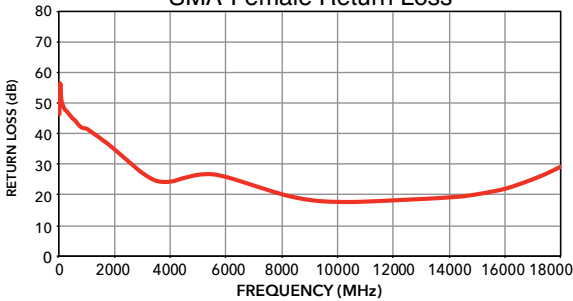

SMA-Male Return Loss

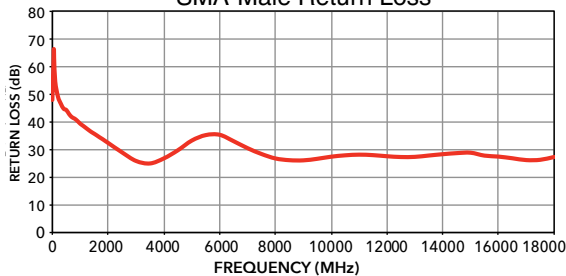

BLK-E653+

Insertion Loss

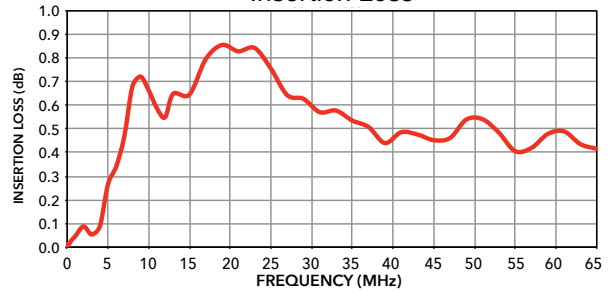

1.85mm-Female Return Loss

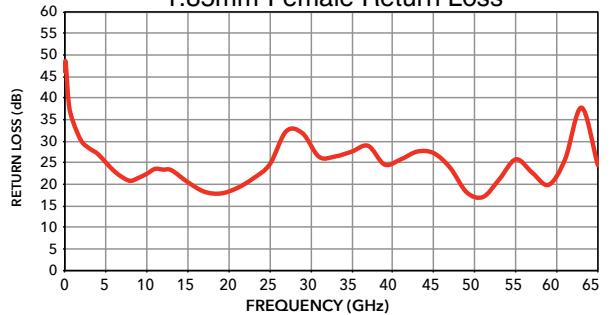

1.85mm-Male Return Loss

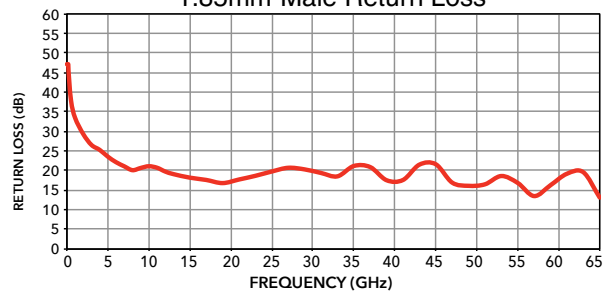

EQUALIZERS



H I G H L I G H T S

- New MMIC fixed equalizers cover DC to 40 GHz
- Application note - Managing Negative Gain Slope with MMIC Fixed Equalizers

50Ω DC to 6 GHz

MMIC Fixed Slope Equalizers

- Excellent Return Loss, 20 dB typ.
- Wide bandwidth, DC - 6 GHz
- Tiny 2x2mm QFN and bare die

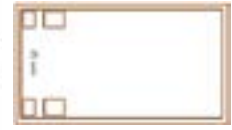

Model Number	Package	Frequency Range (GHz)	Impedance (Ω)	Insertion Loss (dB) @ Freq. Range	VSWR (:1) Typ. Input	VSWR (:1) Typ. Output	Max Input Power (dBm)
EQY-1-63+ EQY-1-63-D+	2x2mm QFN Die	DC-6	50	1.6-0.4	1.24	1.24	31
EQY-2-63+ EQY-2-63-D+	2x2mm QFN Die	DC-6	50	2.5-0.4	1.29	1.29	31
EQY-3-63+ EQY-3-63-D+	2x2mm QFN Die	DC-6	50	3.8-0.6	1.29	1.29	31
EQY-4-63+ EQY-4-63-D+	2x2mm QFN Die	DC-6	50	4.8-0.6	1.25	1.25	31
EQY-5-63+ EQY-5-63-D+	2x2mm QFN Die	DC-6	50	6-1	1.24	1.24	31
EQY-6-63+ EQY-6-63-D+	2x2mm QFN Die	DC-6	50	7-0.5	1.2	1.2	32
EQY-8-63+ EQY-8-63-D+	2x2mm QFN Die	DC-6	50	8.7-0.5	1.21	1.21	31
EQY-10-63+ EQY-10-63-D+	2x2mm QFN Die	DC-6	50	11.2-1	1.12	1.12	31

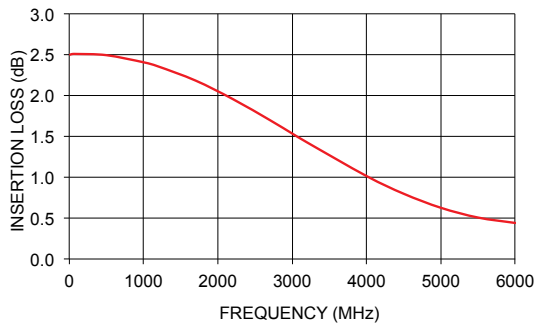
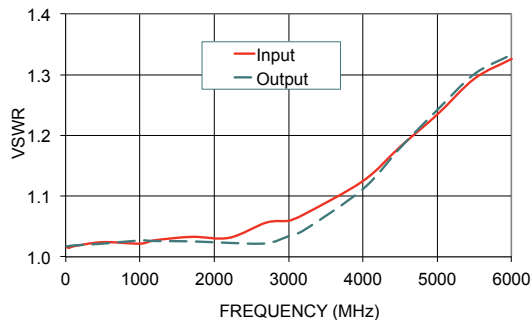
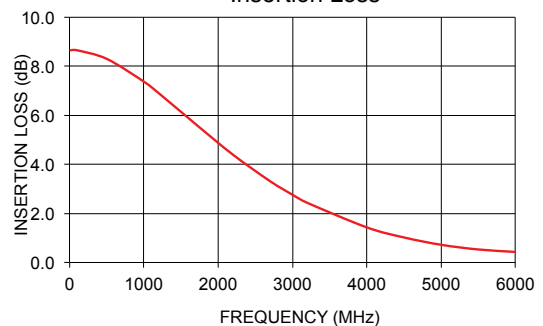
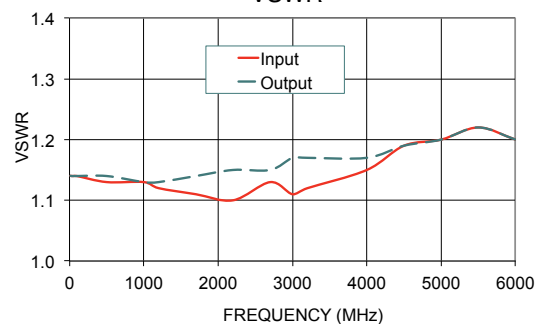
EQY-3-63+**Insertion Loss****VSWR****EQY-8-63+****Insertion Loss****VSWR**



FLATTENING NEGATIVE GAIN SLOPE
WITH MMIC FIXED
EQUALIZERS
APPLICATION NOTE

I. Introduction

Equalizers are devices used to compensate for negative gain slope in the frequency response of a wide variety of RF systems. Unlike a standard attenuator with a flat frequency response, an equalizer is a unique kind of attenuator which exhibits lower insertion loss as frequency increases with some known slope. This is a useful characteristic for system designers working in wideband applications where the gain response of circuit elements or of the entire RF chain often varies across frequency.

For example, an 8 dB fixed slope equalizer may be cascaded with an amplifier that exhibits a negative 8 dB gain slope to flatten the amplifier gain response (**Figure 1a**). Likewise, an amplifier may also be paired with an equalizer of a greater dB slope value to create a net positive gain slope response (**Figure 1b**). This technique is sometimes used to compensate

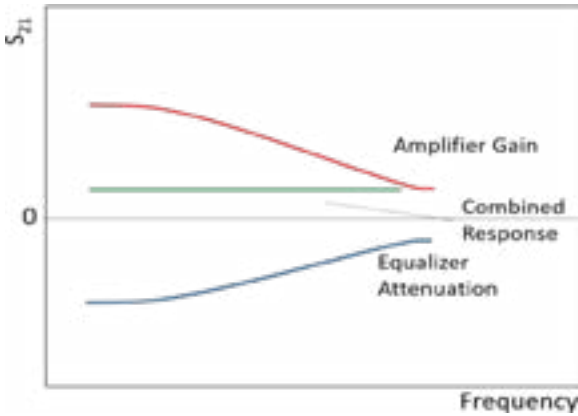

Figure 1a: Combining an amplifier and equalizer with the same dB slope value to create a flat gain response across frequency.

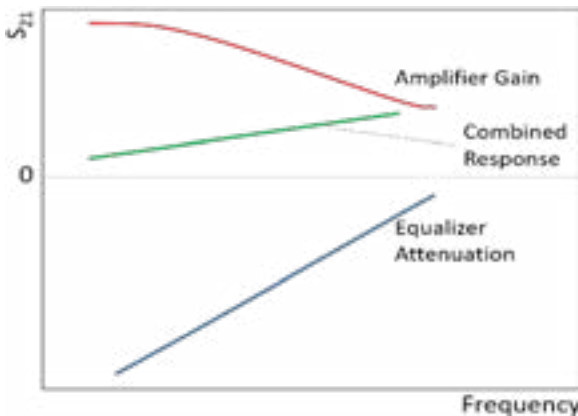

Figure 1b: Combining an amplifier and equalizer with different slope values to create a net positive gain slope response. This technique may be used to compensate for the cascaded effects of other elements in the system chain.

for the cascaded effects of other elements in the RF chain and achieve a flatter overall system gain slope.

To illustrate their functionality, this application note explores how equalizers are used specifically to compensate for negative gain slope in wideband amplifiers. The different types of equalizers and their various characteristics are reviewed, a case study is presented pairing Mini-Circuits' PHA-1+ wideband MMIC amplifier with MMIC equalizer EQY-6-63+, and test data is provided to illustrate the combined response of the pair.

II. Managing Negative Gain Slope

Most general purpose MMIC amplifiers operate over wide bandwidths, covering multiple application bands. Such amplifiers often exhibit a gain response that decreases with frequency. This is especially true for wideband amplifiers with high gain. Negative gain slope can be a major limitation for broadband applications which require consistent gain performance across wide frequency ranges. Undesirable slope in the gain vs. frequency response may be exacerbated by cascading such amplifiers in series, which is a common technique to increase overall gain.

One way to get around the problem is to use different amplifiers for different frequency bands with specific gain values in narrow bandwidths. However, limitations on cost, component count, and board space all make this piecewise approach impractical, and it is usually preferable to use one device with flat gain over a wide bandwidth. This is where equalizers come in. Cascading an equalizer with a wideband amplifier cancels the amplifier gain variation to create a gain-flattening response. One tradeoff is that some gain will be sacrificed for flatness over a wider usable bandwidth. Additionally, adding the equalizer at the amplifier input will sacrifice some noise figure performance, while adding it at the output will sacrifice some output power, and the user must determine which parameter is a higher priority for overall system performance.

III. The Different Types of Equalizers

There are four basic types of equalizers available, each of which may be appropriate depending on the specific application and the amplifier being used:

- **Positive Slope Equalizers (Figure 2)** exhibit an insertion loss response with a positive slope vs. frequency. This type of equalizer is used to equalize amplifiers or systems with positive gain slope.

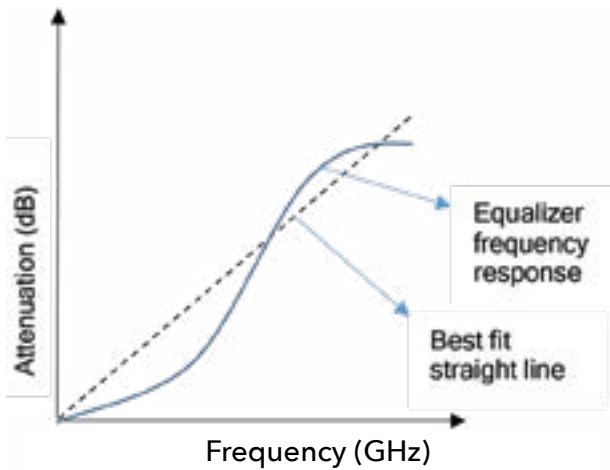

Figure 2: Positive slope equalizer

- **Positive Parabolic Equalizers (Figure 4)** have an insertion loss response that increases in a parabolic shape as frequency increases. These are used to equalize gain variation in systems that have high gain at the band edges and low gain near the center frequency.

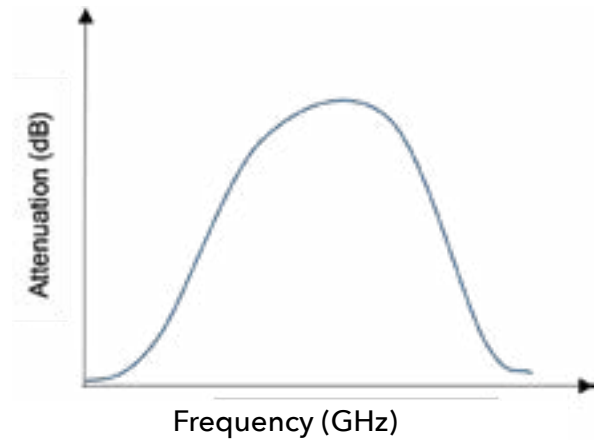

Figure 4: Positive parabolic equalizer

- **Negative Slope Equalizers (Figure 3)** exhibit an insertion loss response that decreases with frequency. This type of equalizer is used to equalize amplifiers or systems with negative gain slope, as in the example below.

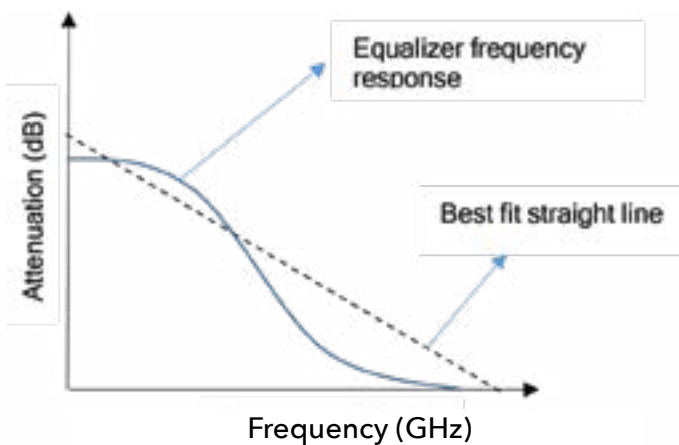

Figure 3: Negative slope equalizer

- **Negative Parabolic Equalizers (Figure 5)** exhibit insertion loss that decreases in a parabolic shape as frequency increases, and are used to equalize gain variation in systems that have low gain at the band edges but high gain at mid-band.

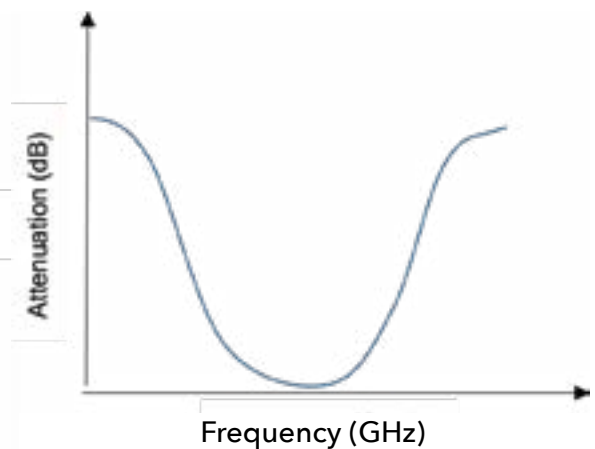

Figure 5: Negative parabolic equalizer

IV. Case Study: Pairing PHA-1+ MMIC Amplifier with EQY-6-63+ Negative Fixed Slope Equalizer

To demonstrate how equalizers can be used to produce a flat gain response from wideband amplifiers, in this example we pair the PHA-1+ high-dynamic range MMIC amplifier with the EQY-6-63+ MMIC fixed equalizer. Mini-Circuits' EQY-series of MMIC negative fixed slope equalizers is available in a range of dB slopes from 1 to 10 dB, allowing users to choose the proper value for the desired combined response with their amplifier. Responses of models EQY-2-63+ (Figure 6) and EQY-6-63+ (Figure 7) shown below exhibit 2 dB and 6 dB slopes, respectively. Additional benefits of these models are the excellent return loss (20 dB typ.), outstanding power handling (+31 dBm typ.) and small package size (2x2mm).

The PHA-1+ amplifier boasts an operating frequency range from 0.5 to 6 GHz, but its gain varies from 16.5 dB at 100 MHz to 10 dB at 6 GHz. The EQY-6-63+ equalizer model has an insertion loss varying from 7 dB at 100 MHz to 0.5 dB at 6 GHz, which makes it an excellent companion for the negative gain slope of the amplifier. We expect the combined response to equalize the gain of the PHA-1+ to a flat value of around 9.5 to 10 dB.

The test setup shown in **Figure 8** was used to test the combined response of the amplifier and equalizer together. Evaluation boards for each unit were

cascaded in series with the equalizer at the amplifier output and connected to a vector network analyzer. Gain and Return Loss were swept over frequency.

To counter any variation in testing, 5 units of PHA-1+ and 3 units of EQY-6-63+ were taken into account. The eval boards for the amplifier and equalizer are shown in **Figures 9a** and **9b** and are available from stock for customers' testing needs.



Figure 8: Test setup for PHA-1+ and EQY-6-63+

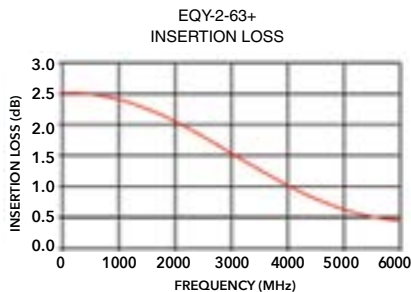

Figure 6: Insertion loss response for EQY-2+ MMIC equalizer with -2 dB slope.



Figure 7: Insertion loss response for EQY-6+ MMIC equalizer with -6 dB slope.

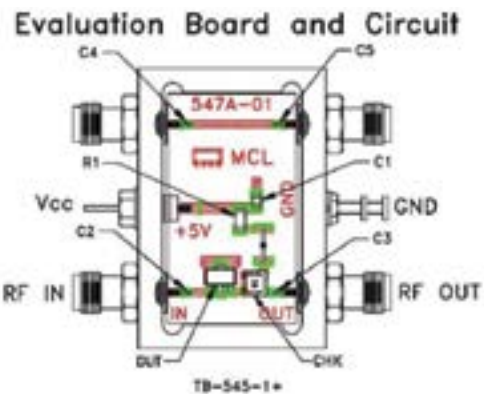

Figure 9a: Evaluation board for PHA-1+ MMIC Amplifier

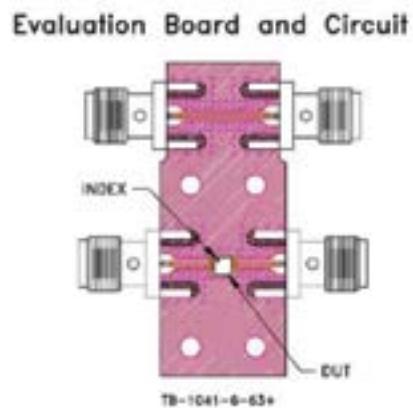

Figure 9b: Evaluation board for EQY-6-63+

V. Test Data

Figures 10 and 11 show the measured insertion loss response of the EQY-6-63+ equalizer with a negative slope of about 6 dB and the gain response of the PHA-1+ amplifier, also with a negative slope of roughly 6 dB. We expect the higher loss at the low end of the equalizer response to flatten the higher gain at the low end of the amplifier response, resulting in flatter overall performance over the 0.5 to 6 GHz range.

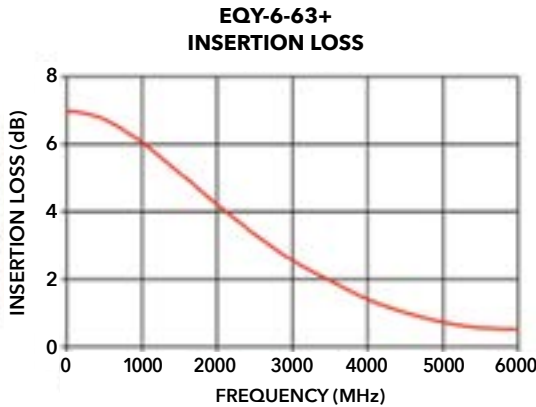

Figure 10: Negative insertion loss slope (6 dB) for EQY-6-63+ MMIC equalizer

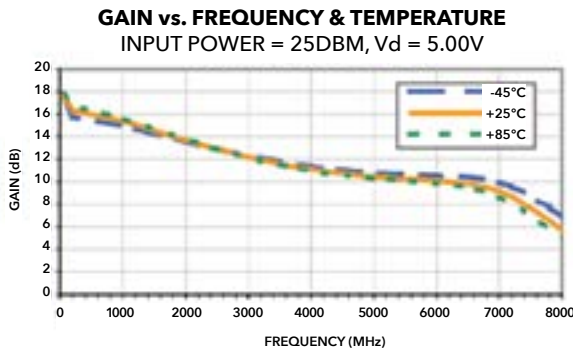

Figure 11: Negative gain slope response for PHA-1+ MMIC amplifier, exhibiting 12 dB gain at mid-band and ± 4 dB variation

Figure 12 shows the measured frequency response PHA-1+ and EQY-6-63+ combined in series on the test board. Note the flat response with mid-band gain of 10 dB and minimal variation of ± 0.6 dB across the entire 0.5 to 6 GHz range. This result bears out the expected effect based on the individual responses of the amplifier and equalizer.

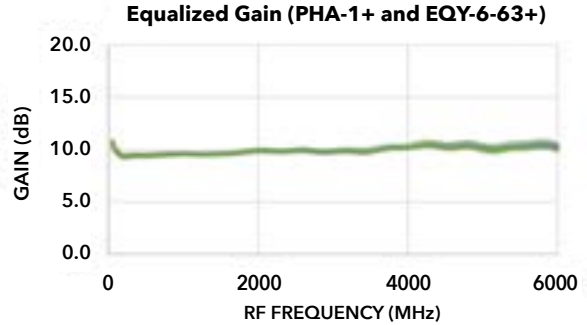

Figure 12: Combined response of PHA-1+ and EQY-6-63+ in series.

Figures 13 and 14 illustrate that the input and output return loss of the cascaded pair are better than or equal to that of the amplifier when used alone. This is due to the excellent return loss of the EQY-6-63+ and great matching over the full bandwidth. The plots in

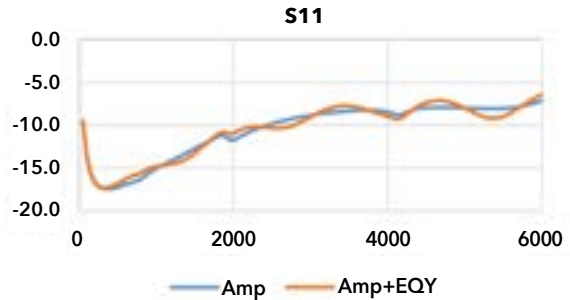

Figure 13: Comparison of input return loss for amplifier alone vs. amplifier-equalizer combination.

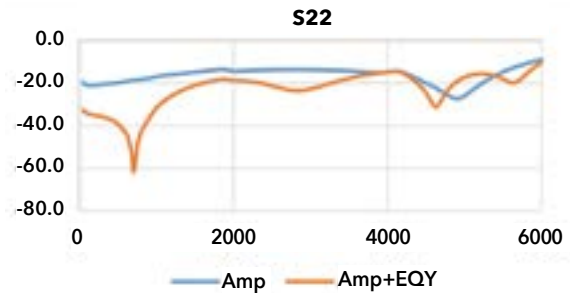

Figure 14: Comparison of output return loss for amplifier alone vs. amplifier-equalizer combination.

Figure 15 shows a comparison of the gain response of the amplifier alone vs. the amplifier-equalizer pair, effectively compensating for the negative gain slope of the amplifier.

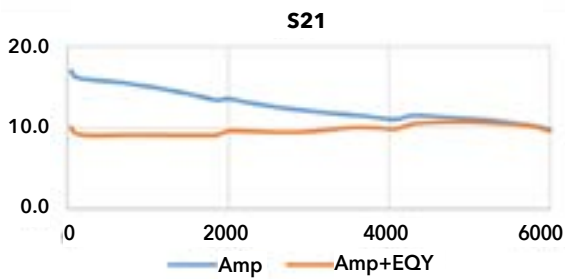

Figure 15: Comparison of gain response for amplifier alone vs. amplifier equalizer combination.

VI. Conclusion

Among all units tested, average flatness of equalized gain fell within ± 1.3 dB. The PHA-1+ has a gain variation of 6 dB from 100 MHz-6000 MHz. By using

the EQY-6-63+ in series with the PHA-1+, we were able to compensate for the gain variation with the negative 6 dB insertion loss slope of the equalizer. The EQY-6-63+ is therefore an excellent match to be used alongside the PHA-1+ amplifier in order to obtain a wideband, flat gain response.

This is just one example of how equalizers can be used to flatten gain response in wideband systems. Additional recommended amplifier-equalizer pairs are provided in the next section. For additional support determining how Mini-Circuits MMIC equalizers may be used with different circuit elements and RF chains, please contact apps@minicircuits.com.

VII. Other Recommended Amplifier- Equalizer Pairs

As an additional example of matches that lead to optimal results, we recommend the following:

Table 1: Additional recommended amplifier-equalizer pair

Amplifier	Equalizer
GVA-62+	EQY-2-63+
GALI-19+	EQY-2-63+
GVA-81+	EQY-3-63+
GVA-63+	EQY-5-63+
PGA-102+	EQY-6-63+
GVA-83+	EQY-8-63+
CMA-84+	EQY-10-63+

FILTERS



H I G H L I G H T S

- LTCC filters with reduced size and enhanced rejection
- New cavity filter models
- New reflectionless filter models

50Ω DC to 2850 MHz

LTCC Low Pass Filters

- Very good rejection, 45 dB typ.
- Rugged, ceramic construction
- Excellent power handling, 6W
- Tiny size, 0805



Model Number	Passband (MHz)	3 dB Cutoff (MHz)	Stopband F3 (MHz)	Rejection@ F3 (dB)	Stopband F4 (MHz)	Rejection@ F4 (dB)	Package size
LFCG-1000+	DC-1000	1370	1550-1900	20	1900-6000	30	0805
LFCG-1575+	DC-1575	1850	2175-2400	20	2400-7000	40	0805
LFCG-1700+	DC-1700	2025	2400-2800	20	2800-8000	30	0805
LFCG-2250+	DC-2250	2500	2800-3600	20	3600-8000	30	0805
LFCG-2850+	DC-2850	3250	3800-4400	20	4400-12000	30	0805

LFCG-1000



LFCG-2850+

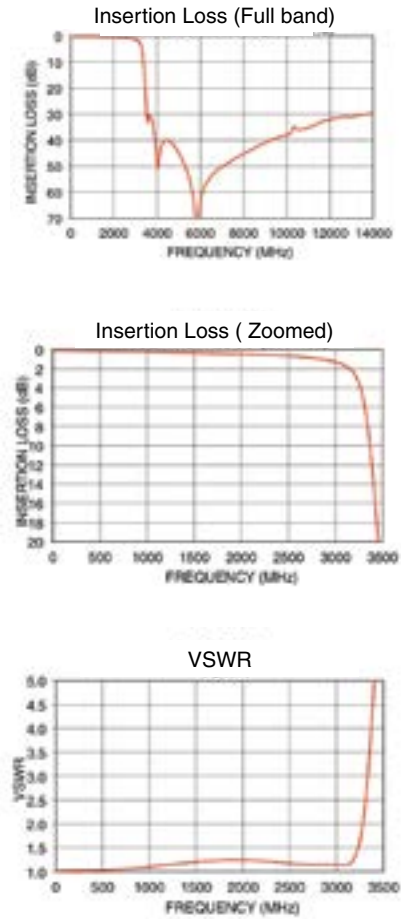

50Ω DC to 15 GHz

Cavity Bandpass Filters

- Very low insertion loss with excellent power handling
- Very fast roll-off with wide stopband
- Passbands up to 15 GHz
- Stopbands up to 20 GHz
- Now 13 models in stock!



LATEST RELEASES

Model Number	Passband (MHz)	Lower Stopband (MHz)	Lower Stopband Rejection (dB)	Upper Stopband (MHz)	Upper Stopband Rejection (dB)	Filter Type
ZVBP-2400+	2375-2425	DC-2250	35	2550 - 6000	35	Band Pass
ZVBP-4000+	3997-4003	DC - 3800	70	4200 - 6000	70	Band Pass
ZVBP-5800+	5725-5875	DC - 5200	35	6400 - 14000	35	Band Pass

ZVBP-2400+
Insertion Loss (Full Band)

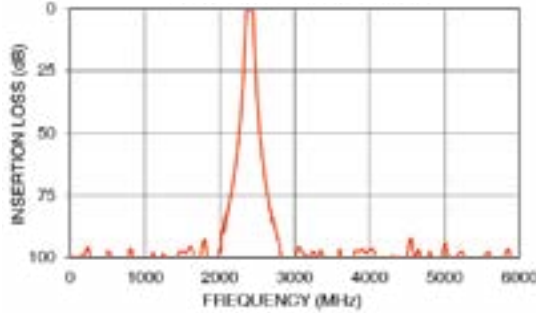

ZVBP-4000+
Insertion Loss (Full Band)

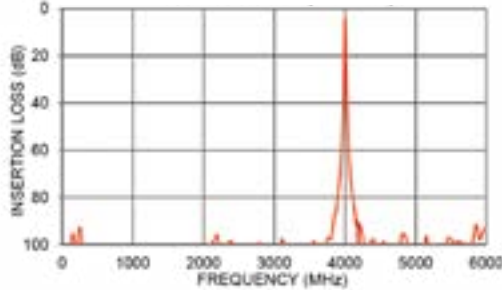

ZVBP-5800+
Insertion Loss (Full Band)

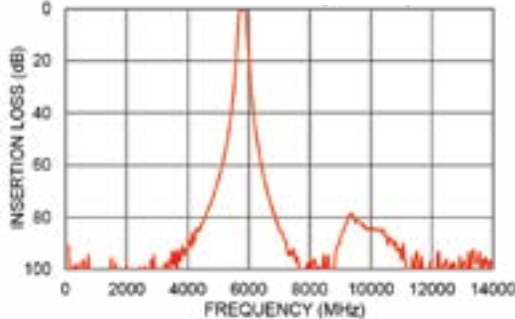

50Ω DC to 40 GHz

MMIC Reflectionless Filters

- Stopband rejection as high as 77 dB
- Patented design terminates stopband signals
- Stopband up to 40 GHz
- Excellent repeatability through IPD* process
- Now over 90 models!



Model Number	Filter Type	Package size	Passband F1 (MHz)	Stopband F3 (MHz)	Rejection @ F3 (dB)	Stopband F4 (MHz)	Rejection @ F4 (dB)
XBF-163-D+	Band Pass	Die	15500 - 16500	DC - 8000	77	24000 - 30000	53
XBF-183-D+	Band Pass	Die	17500 - 18500	DC - 9000	77	27000 - 32000	50
XBF-24-D+	Band Pass	Die	19500 - 20500	DC - 10000	76	30000 - 32000	49
XHF-63M+	High Pass	3 x 3 mm	5900 - 19000	3000-4100	30	DC-3000	40
XHF-14M-D+	High Pass	Die	9900 - 26000	5000 - 7000	32	DC - 5000	41
XHF-143M+	High Pass	3 x 3 mm	13900 - 19000	7000-8000	30	DC-7000	40
XBF-24+	Band Pass	4 x 4 mm	19500 - 20500	DC - 10000	66	30000 - 32000	55

XBF-24+

Insertion Loss

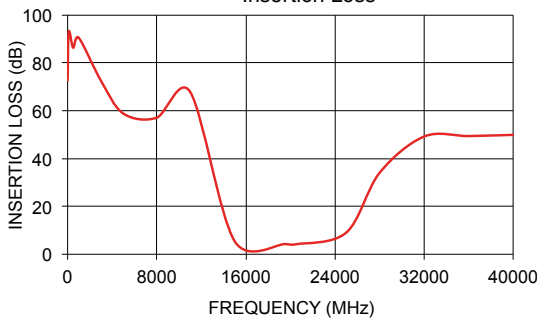

VSWR

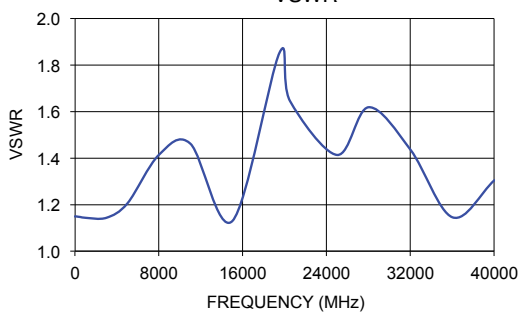

XBF-183-D+

Insertion Loss

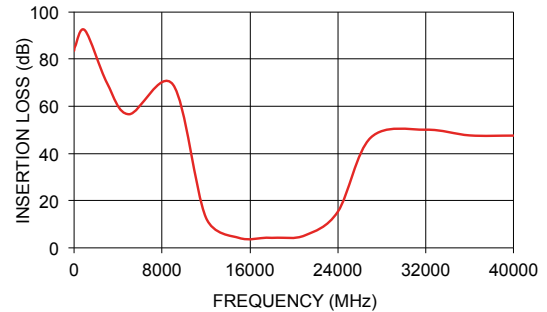

VSWR

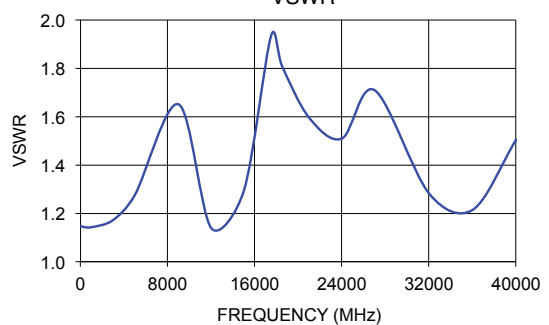

SPLITTERS COMBINERS & HYBRIDS



H I G H L I G H T S

- Coaxial models up to 65 GHz
- New splitter/diplexer distributes IF and reference signal on the same line
- 5W 16-way design for VHF/UHF
- New high-power stripline-based surface mount designs
- Coaxial models with multi-octave bandwidths up to 26.5 GHz

50Ω 10 to 65 GHz

Ultra-Wideband Splitter/Combiners

- Insertion loss as low as 1.2 dB
- Isolation up to 23 dB
- 10W power handling



Model Number	No. of Ways	Frequency Range MHz	Isolation (dB), Typ.	Insertion Loss (dB) Above Theoretical, Typ.	Phase Unbalance (deg), Typ.	Amplitude Unbalance (dB), Typ.	Power Input (W) as Splitter, Max.	DC Pass
ZN2PD-E653+	2	10000-65000	22	1.2	10.7	0.64	10	Y
ZN2PD-V54+	2	10000-50000	23	1.8	2.7	0.13	10	Y

ZN2PD-E653+

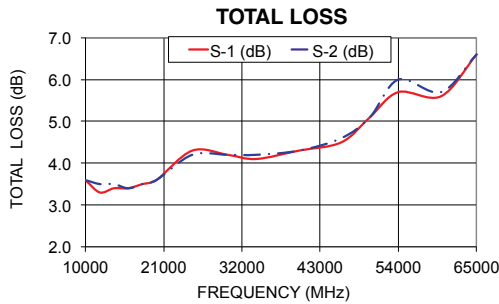
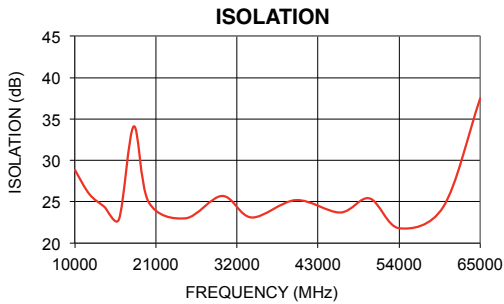
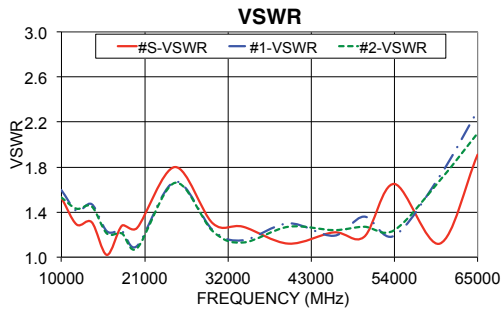

ZN2PD-V54+

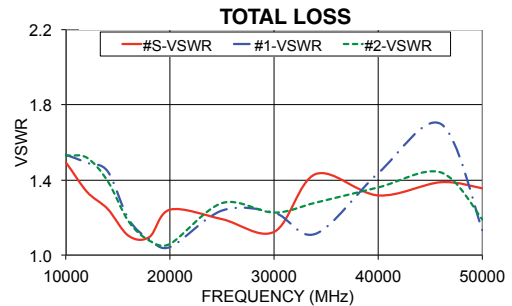
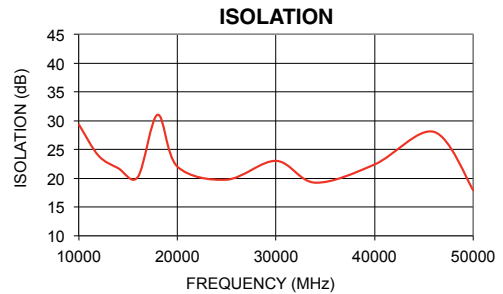
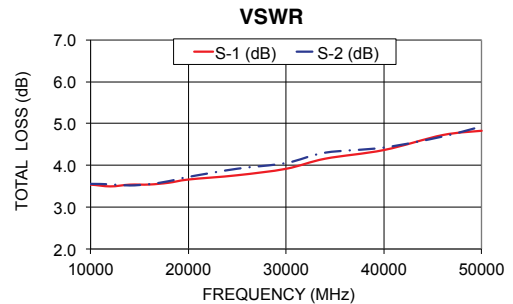

50Ω 1 to 100 MHz, 2450 to 2700 MHz

8-Way Connectorized Splitter/Diplexer

- Distributes IF and reference signals on the same line
- Excellent VSWR, 1.2:1 typ.
- Good isolation, 22 dB



Model Number	Channel	Frequency Range (MHz)	Isolation (dB), Typ.	Insertion Loss ± X (dB) above 9 dB Typ.	Phase Unbalance (deg.) Typ.	Amplitude Unbalance (dB) Max.
ZC8SC272-12DL+	High Pass	1-100	30	0.5	0.2	0.1
	Low Pass	2450-2700	22	2	7	0.6

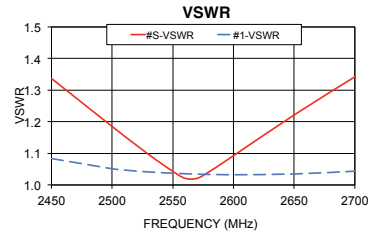
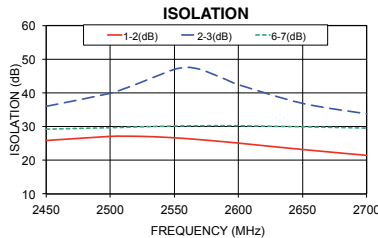
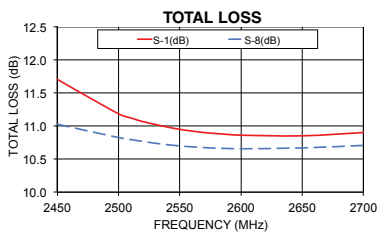

50Ω 1 to 250 MHz 5 Watt

16-Way VHF/UHF Splitter/Combiner

- High IP2 (+70 dB) and IP3 (+50 dB) at 1W input
- Low insertion loss, 2.6 dB
- Good isolation, 25 dB
- Excellent output VSWR, 1.1:1



Model Number	Frequency Range (MHz)	Isolation (dB), Typ.	Insertion Loss (dB) above 12 dB, Typ.	Phase Unbalance (deg.) Typ.	Amplitude Unbalance (dB), Typ.
ZC16PD-251+	1-250	25	3	4	0.3

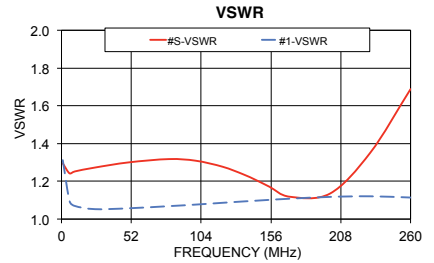
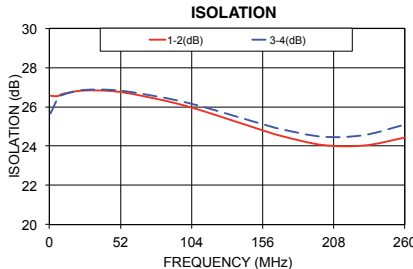
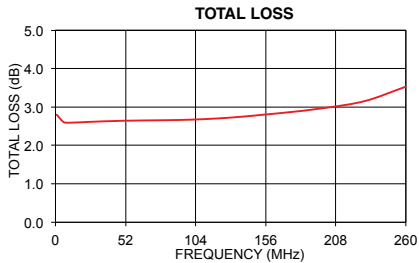

SPLITTERS/COMBINERS

50Ω 225 to 1200 MHz

High Power 2 Way-90° Hybrids

- Power handling up to 250W
- Very low insertion loss
- Miniature surface mount form factor

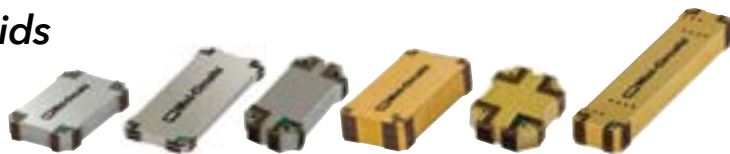

Model Number	Frequency Range (MHz)	Isolation (dB), Typ.	Insertion Loss (dB) above 3 dB, Typ.	Phase Unbalance (deg), Max.	Amplitude Unbalance (dB), Max.	Input Power (W)
QCH-63	2000-6000	26	0.2	5	1.4	200
QCH-83	4000-8000	23	0.15	-	1.3	75
QCH-63B+	800-6000	20	0.5	-	2.6	70
QCH-123+	8000-12000	23	0.25	-	1	50
QCH-272+	700-2700	22	0.3	5	1	200
QCH-382+	800-3800	28	0.25	7.5	1.3	150
QCH-392+	60-3900	14	0.6	12	2.5	90
QCH-451	225-450	27	0.2	5	0.5	250
QCH-652+	1000-6500	19	0.6	-	1.8	60

50Ω 0.5 to 26.5 GHz

Ultra-Wideband 2, 4, 8 Way-0° Splitters

- Multi-octave bandwidths to 26.5 GHz
- Low insertion loss, 1.2 dB typ.
- High Isolation, 35 dB typ.



Model Number	No. of Ways	Frequency Range (MHz)	Isolation (dB), Typ.	Insertion Loss (dB) Above Theoretical, Typ.	Phase Unbalance (deg), Typ.	Amplitude Unbalance (dB), Typ.
ZC2PD-5R263+	2	500-26500	35	1.2	0.6	0.05
ZC2PD-01263+	2	1000-26500	33	0.7	0.7	0.04
ZC2PD-02263+	2	2000-26500	31	0.6	0.69	0.04
ZC2PD-06263+	2	6000-26500	27	0.4	0.4	0.03
ZC4PD-01263+	4	1000-26500	33	1.6	1.9	0.06
ZC4PD-02263+	4	2000-26500	31	1.5	1.5	0.07
ZC8PD-06263+	8	6000-26500	28	1.2	2.6	0.11

ZC8PD-06263+
TOTAL LOSS

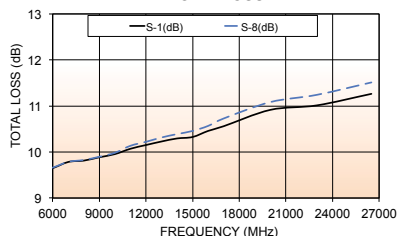

ZC8PD-06263+
ISOLATION

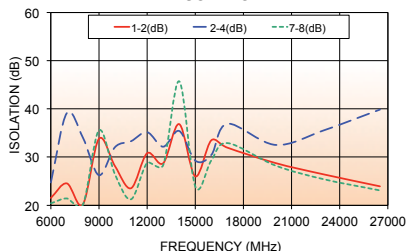

ZC8PD-06263+
VSWR

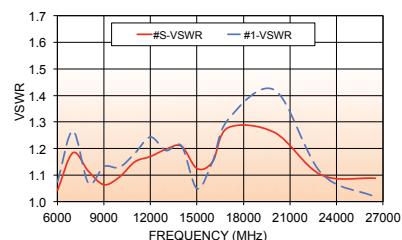

SWITCHES



H I G H L I G H T S

- High isolation solid state switches with USB, I²C and SPI control
- New coaxial solid state switches with internal driver

50Ω 2 to 6000 MHz

USB/I²C/SPI Controlled Solid State Switches

- High speed switch transition
- Unique designs provide high isolation, up to 110 dB
- Wide variety of SPDT, SP4T, SP8T, SP10T and SP16T switch configurations
- User-friendly GUI and DLLs included

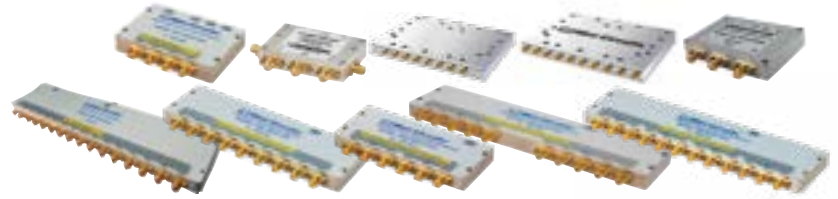

Model Number	Switch Type	Control Interface	Number of Switches	Frequency Range (MHz)	Insertion Loss (dB), Typ	Isolation (dB), Typ	VSWR (:1), Typ	Switching Time (usec), Typ	Supply Voltage (V), Typ	Max Input Power (W)
SPI-SP8T-6G	SP8T	SPI	1	1-6000	4	90	1.25	6	5-24	0.5
SPI-SP10T-63	SP10T	SPI	1	1-6000	4	90	1.25	6	12-24	0.5
U2C-1SP2T-63VH	SPDT	USB / I ² C / SPI	1	10-6000	4	110	1.3	0.7	USB (5V) or 12-24	2
U2C-1SP4T-63H	SP4T	USB / I ² C	1	2-6000	3.7	80	1.25	0.25	5	1
USB-1SP16T-83H	SP16T	USB / TTL	1	1-8000	7.5	100	1.3	5.5	USB (5V)	1
USB-1SP8T-63H	SP8T	USB	1	10-6000	4	80	1.25	0.25	USB (5V)	1
USB-2SP2T-DCH	SPDT	USB	2	DC-8000	1.4	50	1.2	14	USB (5V)	3.15
USB-2SP4T-63H	SP4T	USB	2	10-6000	2.5	85	1.3	1.5	USB (5V)	1
USB-4SP2T-63H	SPDT	USB	4	10-6000	2	80	1.25	0.25	USB (5V)	1
USB-SP4T-63	SP4T	USB	1	1-6000	1	50	1.2	3	USB (5V)	0.5

50Ω DC to 5 GHz

Reflective Solid State Switches

- High Isolation, 70 dB typ.
- Very fast switching, 20ns typ.
- Low video break thru 45 mVp-p typ.
- Internal TTL driver



Model Number	Frequency Range (GHz)	Insertion Loss (dB), Typ.	1 dB Compression (dBm), Typ.	In-Out Isolation (dB), Typ.
ZASW-2-50DRA+	DC-5	2.2	22	65
ZASWA-2-50DRA+	DC-5	2.2	22	70
ZASWA2-50DR-FA+	DC-5	2.2	22	70
ZYSW-2-50DR+	DC-5	1.4	22	25
ZYSWA-2-50DR+	DC-5	1.4	22	28

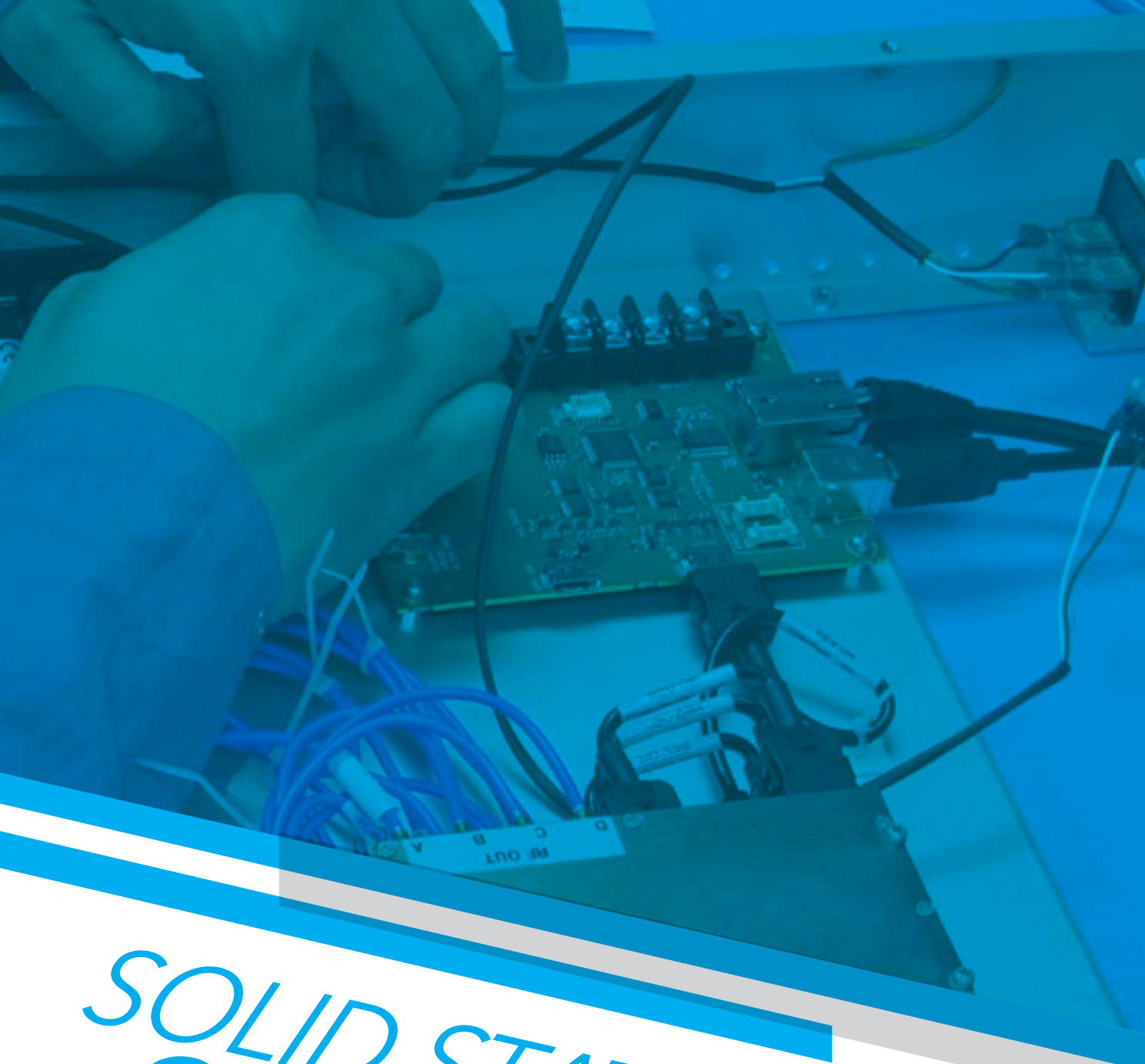

SOLID STATE SWITCHING

*For Next Generation
Wireless Test Applications*

APPLICATION NOTE

I. Introduction

Rapid growth in the number of connected devices for next generation wireless applications is driving demand for faster, more innovative, and more cost-effective test solutions. The need for reduction in cost and improvement in test throughput is found both at the design verification stage as well as in high-volume production testing. Test engineers are looking for ways to reduce the number of device-under-test (DUT) connections and enable testing of multiple DUTs in parallel from a single test station. This is most often achieved by configuring RF switches in a switch matrix to automate the routing of test signals. This article will explore some of the key differences between the types of switches used in test applications. Switch matrix configurations will be discussed, and a real world switch matrix for a high-volume telecom test application described in detail.

II. Key Design Distinctions between Solid State and Mechanical Switches

RF switches fall into two basic design categories: electro-mechanical and solid state (**Figure 1**). Some of the key performance parameters of RF switches for test applications include isolation, insertion loss, power handling, switching time, and switch life. Mechanical switches tend to support higher power, have lower loss, and better isolation. However, they have slower switching times, are larger in size, and their repeatability begins to degrade after several million switching cycles.

Solid state switches, by contrast, tend to have much faster switching speeds and better repeatability over a greater number of switching cycles. These attributes are especially desirable for high-volume production test applications, as switching speed is directly related to test throughput, and the switches need to be replaced far less often under heavy use. At the same time, they come with limitations of lower power handling and lower isolation. Isolation in particular is more difficult to calibrate out of a test system and is therefore an especially critical parameter for automated testing. Switches with poor isolation can allow stray signals to flow into the measurement path and degrade the integrity of the measurement. This can impair system accuracy and lead to challenges in determining uncertainties and timing requirements.



Figure 1: SP8T electromechanical switch, MSP8T-12D+ (left), and dual SPDT solid state switch, USB-2SP2T-DCH (right). No single switch design meets all test needs. Tradeoffs are often required on performance, speed, and number of switching cycles

In general, solid state switches have many advantages for high volume test applications. Below is a brief overview of how design differences between the two switch types affect key performance parameters for test setups.

Switching Speed

One of the most important differences between mechanical and solid state switch designs is in their switching speeds. When a given state is energized in a mechanical switch, a conductive reed or armature strikes an electrical contact to connect the signal from the common port to the active output. When this happens, the reed may bounce 2 or 3 times before settling, during which time the electrical contact rapidly connects and disconnects before the connection is stable. This “settling time” is considered part of the overall switching time, so while it may take 8-9 mS for the switch to change states, the settling time may add 12-15 mS to the overall switching time.

Solid state switches rely on a change in electrical field rather than moving parts and mechanical connections. There is thus no settling time, and overall switching speed is much faster – in the order of micro- and nano-seconds rather than milliseconds.

Switch Life

Because the connection in a mechanical switch relies on mechanical contact between two surfaces, in order to minimize resistance, the two surfaces need to be as flush to each other as possible. As the reed and the contact repeatedly connect and disconnect over time, the contact surfaces can change shape and wear-off oxidation can form, degrading the electrical connection and the performance of the switch.

Mini-Circuits’ mechanical switches use patented technology to guarantee switch life up to 10 million cycles and give customers outstanding longevity. The unique construction of our mechanical switch models makes it very practical to clean the switch contact assembly, enabling performance recovery and extending switch life to over 100 million cycles.

Still, solid state switches have no moving parts, and mechanical degradation of the electrical contact isn’t a problem. As a result, overall switch life is much longer than that of even the most robust mechanical switch.

Transient Voltages

Most electromechanical switches incorporate a coil to create a magnetic field. When voltage is removed from the coil, the field collapses which causes “flyback” or “kickback” of the current in the opposite direction. This can create a transient voltage which adds noise and other unwanted effects to the system and even damage other elements in the circuit. This is why mechanical switches are often outfitted with an integrated or external surge protector.

Solid state switches have no magnetic field and no kickback. Therefore, transient voltages and auxiliary surge protection are not a concern.

Isolation

Mechanical switches typically offer higher isolation than solid state switches. One of the traditional drawbacks of using solid state switches for test applications is the potential effect of stray signals on uncertainty and system accuracy. Solid state switches are typically constructed with either PIN diode switches or FET switches. PIN diode switches offer better isolation performance at high frequencies but have poorer isolation at lower frequencies (<40 MHz) due to the inherent limitations of the technology. FET switches have good isolation at low frequencies, but at higher frequencies they underperform due to the FETs' drain-source capacitance in the off state. Today, switch designers are creating hybrid designs that optimize the desired features of both FET and PIN diode switches.

Mini-Circuits engineers have innovated solid state switch designs to dramatically improve isolation performance over wide bandwidths and circumvent some of the challenges associated with lower isolation. Mini-Circuits now offers a wide variety of cost-effective, USB-controlled solid state switches with frequencies ranging from DC to 8 GHz and isolation ranging from 50 up to 110 dB. Meanwhile these models retain the advantages of long switching life and switching speeds specified in microseconds (even nanoseconds) rather than milliseconds. Their compact, low profile size also helps reduce the overall size of the test system.

Table 1 highlights the performance of a few of our solid state switch models.

III. Real World Example - Switch Matrix for Telecommunications Testing

RF and microwave switches used in real-world test applications are often configured together into a switch matrix to manage and automate signal traffic. Since all test signals pass through the switch matrix, its performance directly effects the accuracy, repeatability, and efficiency of your measurements. In building a given test setup, test engineers need to focus on getting their DUTs properly tested in the most efficient manner possible. Primary concerns are that the test solution employed delivers the correct signal at the required power level to the DUT and that the isolation between test ports maintains measurement integrity.

Determining switch matrix routing and performance for complex, application-specific test systems can become very costly and time consuming. Moreover, system requirements tend to be unique to a given application, and there's no one-size-fits-all solution. To support customers in this task, Mini-Circuits offers a wide range of modular and fully customized integrated solutions, including high-order switch matrices for signal routing. Whether these systems incorporate mechanical or solid state switching in a given system is determined based on your specific system requirements.

Let's consider a real example supporting telecom test applications from 600 MHz to 6 GHz. **Figure 2** highlights an 8 x 24 switch matrix subassembly. This unit was part of a larger, 24 x 48 system that included signal conditioning. In this case, the switch matrix had to provide a maximum path loss of 12 dB and provide 120 dB of isolation between test ports. The goal was to meet throughput requirements of less than 30 millisecond DUT test time.

In order to meet the design requirements, the system utilized a combination of mechanical and solid state

Table 1. Selected examples of Mini-Circuits high-performance solid-state switches. Mini-Circuits models offer a wide range of switch configurations, control interfaces, and performance parameters.



Model Number	U2C-1SP2T-63VH	USB-2SP2T-DCH	USB-4SP2T-63H	SPI-SP10T-63
Frequency Range	10 to 6000 MHz	DC to 8000 MHz	10 to 6000 MHz	1 to 6000 MHz
Switch Type	SPDT	Dual SPDT	Quad SPDT	SP10T
Isolation	110 dB	50 dB up to 4 GHz	65 dB	80 dB
Switching Time*	700 ns	14 µsec	250 nsec	6 µsec
Insertion Loss	5.0 dB	1.5 dB	2.8 dB	5.0 dB
Power Handling	+33 dBm	+35 dBm	+ 30 dBm	+27 dBm

*Specified without communication delays. Switching time spec represents the time that the RF signal paths are interrupted during switching.

switches. On the 8-port side we used mechanical SP4T switches (MSP4TA-18+), which provided 0.2 dB insertion loss and 90 dB isolation. The MSP4TA's 20 millisecond switching speed meets the overall test time required at this stage of the signal routing plan.

Figure 2 illustrates the elaborate switching network beyond the SP4T switches. To accomplish this signal routing and still meet the test time requirement, we used our SPI-controlled RF SP10T solid state switches (SPI-SP10T-63). With this model's 6 microsecond switching speed, all the solid state switching routes can be cycled in less time than the mechanical switch performs a single cycle. It also provides 80 dB isolation and +27 dBm power handling, meeting the requirements for this telecom application. The configuration in this example takes advantage of the benefits of both switching types and allows for a wide range of testing to be performed.

IV. Meeting Your Requirements

As the industry works to develop a growing number and variety of wireless devices, the need for fast, efficient, and cost effective solutions for RF testing will continue to grow in kind. With this progression in mind, this article has provided a review of the features and relative advantages of the different switch types used for signal routing in RF test systems. Mini-Circuits' solid state switches offer the advantages of fast switching and long life together with very high isolation, which is unique among switches in this class. Together with our full lineup of mechanical and solid state switches, this gives test engineers a wealth of options, whether using discrete components in their native setups, or sourcing a fully integrated solution.

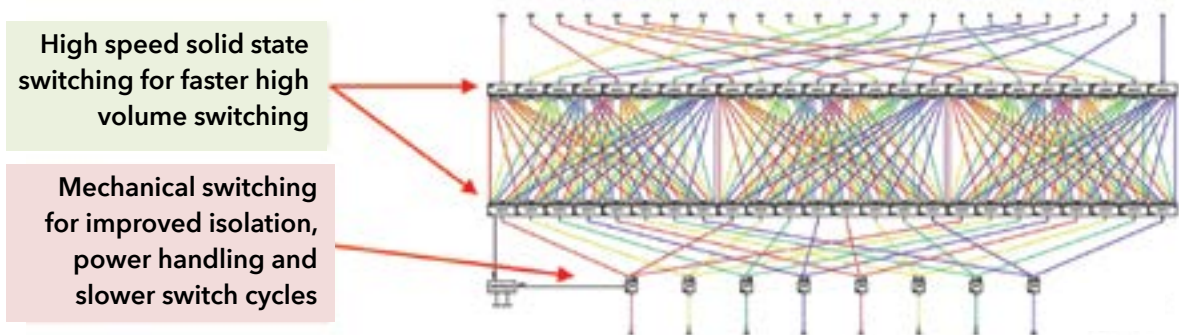

Figure 2: Switch matrix designs are optimized to take advantage of each switches' unique performance parameters.

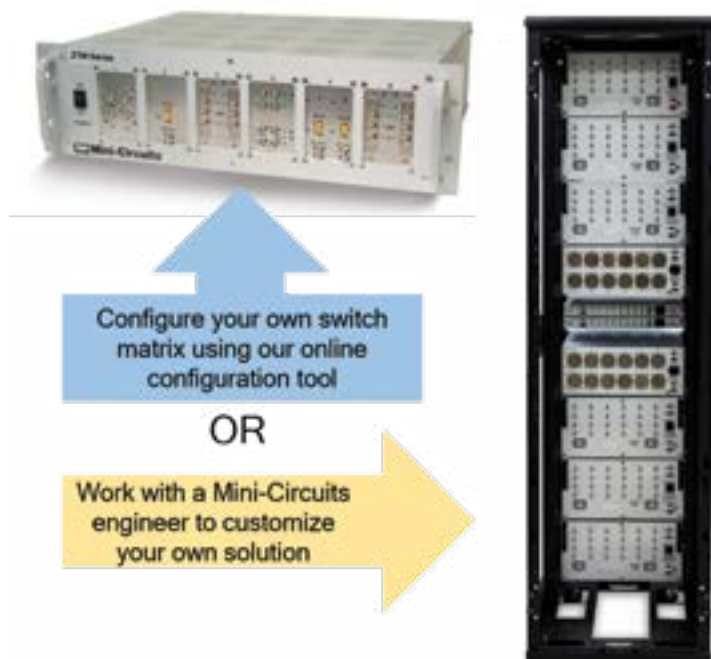

Figure 3: Mini-Circuits offers a variety of methods for meeting your signal routing and conditioning needs. You can build it yourself with our components, use our online solution configurator, or work with our application specialists for a solution customized to your requirements.

TEST SOLUTIONS



H I G H L I G H T S

- USB/Ethernet transfer switch module
- Rack mount switch systems to 26.5 GHz

50Ω DC to 18 GHz

RF Transfer Switch Matrix

- Dual mechanical transfer switch
- High reliability, 10 million switch cycles
- 10W power rating (cold switching)
- User-friendly GUI and DLLs included



Switching States (per Switch)

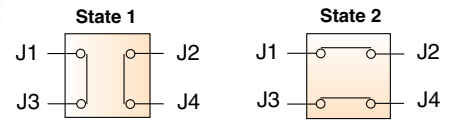

Model Number	Switch Type	Number of Switches	Control Interfaces	F. Low (GHz)	F. High (GHz)	Insertion Loss (dB), Typ.	Isolation (dB), Typ.	VSWR (:1), Typ.	RF Power (W), Max.
RC-2MTS-18	Transfer Switch	2	USB & Ethernet	DC	18	0.2	86	1.15	10

50Ω DC to 26.5 GHz

Rack-Mount SPDT Switch Matrices

- High reliability, 10 million switch cycles
- 20W power rating (cold switching)
- High isolation, 85 dB typ.
- 19" rack mount chassis
- User-friendly GUI and DLLs included



Model Number	Switch Type	Control Interfaces	Number of Switches	Freq. Low (GHz)	Freq. High (GHz)	Insertion Loss (dB), Typ.	Isolation (dB), Typ.	VSWR (:1), Typ.	RF Power (W), Max.
ZTRC-4SPDT-A26	SPDT	USB & Ethernet	4	DC	26.5	0.25	80	1.2	20
ZTRC-4SPDT-A18	SPDT	USB & Ethernet	4	DC	18	0.25	80	1.2	20
ZTRC-8SPDT-A18	SPDT	USB & Ethernet	8	DC	18	0.25	80	1.2	20
ZTRC-8SPDT-A26	SPDT	USB & Ethernet	8	DC	26.5	0.25	80	1.2	20

ZTRC-4SPDT-A26 GUI Main Screen

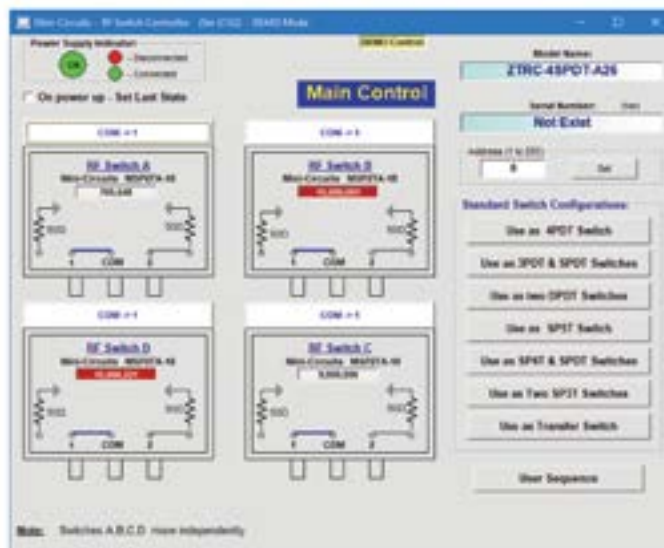

TRANSFORMERS & BALUNS



H I G H L I G H T S

- New high-power surface mount models
- New tiny LTCC models as small as 0603

50Ω 1 to 9000 MHz

High Power Surface Mount Transformers

- High power handling, up to 20W
- Low phase unbalance
- Low insertion loss, as low as 0.30

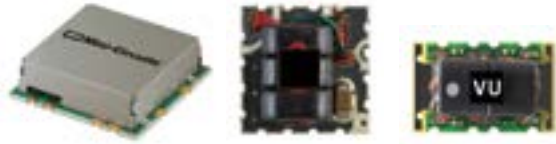

Model Number	Frequency Range (MHz)	Impedance (Ω)	Impedance Ratio	Technology	Power Handling (W)
SCTX2-93-2W+	10 - 9000	50	2	CORE & WIRE	2
SYTX1-52HP-15W+	20 - 520	50	1	CORE & WIRE	15
SCTX4-32HP-20W+	1 - 310	50	4	CORE & WIRE	10

STYX-52HP-15W

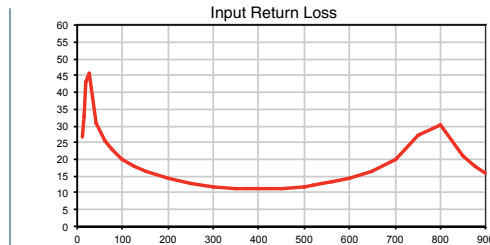
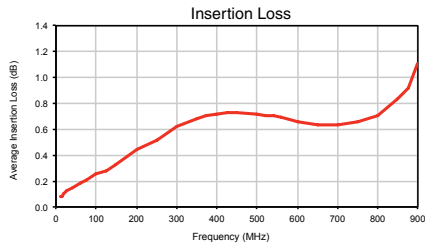

50Ω 1700 to 5875 MHz

Tiny LTCC Balun Transformers

- Miniature size 0603 (1.6x0.8mm)
- Low unbalance, as low as 0.2 dB, 3°
- LTCC construction
- Low cost



Model Number	Frequency Range (MHz)	Impedance (Ω)	Impedance Ratio
TCW1-272+	1700 - 2700	50	1
TCW1-3901+	3300 - 3900	50	1
TCW2-63+	4900 - 5875	50	2
TCW2-272+	2100 - 2700	50	2
TCW1-33+	2300 - 3000	50	1

TCW1-272+

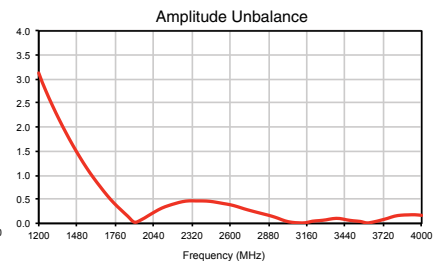
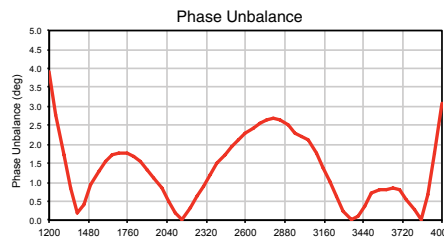
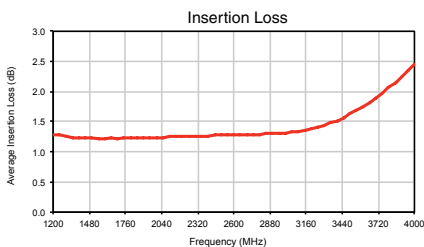

VCO'S



H I G H L I G H T S

- Wide variety of new coaxial and surface-mount designs

50Ω 1900 to 4000 MHz

Coaxial Voltage Controlled Oscillators

- Low Phase Noise
- Robust design and construction
- Rigid unibody construction



Model Number	Frequency Range (MHz)	Power Output (dBm) Typ.	Phase Noise dBc/Hz SSB at offset frequencies, kHz Typ.				Tune Voltage (V) Min. - Max.		Tuning Sensitivity (MHz/V) Typ.	3 dB Control BW (MHz), Typ.	Harmonics (dBc), Typ.	Pulling (MHz) pk - pk @ 12 dB, Typ.	Pushing (MHz/V), Typ.	DC Operating Power	
			1	10	100	1000	Min.	Max.						Vcc (volts)	Current (mA)
ZX95-3360R+	2120-3360	9	-64	-93	-116	-136	0.5 - 18	77-123	170	-20	9	1.5	12	45	
ZX95-3800AR+	1900-3700	6	-61	-88	-110	-130	0.5 - 20	60-150	10	-22	2	6	6	55	
ZX95-4000R+	3850-4000	5	-74	-99	-120	-140	0.5 - 10	24-36	13	-26	5	1.5	5	42	

50Ω 875 to 4861 MHz

VCOs, Surface Mount, Linear Tuning, Wideband

- Low Phase Noise
- Linear Tuning
- Robust design and construction
- Small size packages, .500 x .500 x .220" & .500 x .500 x .180"



Model Number	Frequency Range (MHz)	Power Output (dBm) Typ.	Tuning Voltage (V)		Phase Noise dBc/Hz SSB at offset frequencies, kHz Typ.				Pulling (MHz) pk-pk @ 12 dB, Typ.	Pushing (MHz/V), Typ.	Tuning Sensitivity (MHz/V) Typ.	Harmonics (dBc)		3 dB Control BW (MHz), Typ.	DC Operating Power	
			Min.	Max.	1	10	100	1000				Typ.	Max.		Vcc (volts)	Current (mA) Max.
ROS-890CR+	875-890	6.2	0.5	11	-97	-125	-145	-165	0.3	0.2	5	-19	-12	60	8	35
ROS-1150C-119R+	1146-1154	3	0.5	11	-96	-121	-141	-161	0.2	0.1	3	-22	-12	45	5	35
ROS-1445-219+	1145-1445	8	1	20	-78	-106	-129	-149	5	0.5	35-42	-12	-	60	10	30
ROS-1745C-219+	1445-1745	6.5	1	20	-81	-107	-127	-147	2.5	0.3	33-47	-20	-11	45	8	34
ROS-2400C-319+	2400-2400	7	0.5	9.5	-93	-121	-144	-164	0.4	0.1	3	-13	-	50	8	37
ROS-3800-119R+	1900-3700	6	0.5	20	-61	-88	-110	-130	2	6	60-150	-22	-10	10	6	55
ROS-4000-419R+	3850-4000	5	0.5	10	-74	-99	-120	-140	5	1.5	24-36	-26	-16	13	5	42
ROS-4861C-119+	4859-4861	7.5	0.5	8	-80	-108	-132	-153	1.5	0.3	5-6	-23	-16	200	8	37
ROS-785-419+	755-785	3	-90	-115	-136	-121	-141	-156	0.2	0.5	10-14	-33	-23	50	5	36
ROS-933C-119+	933-933	0	-97	-123	-144	-163	0.1	0.05	3.8	-23	-14	10	5.0	35	10	30
ROS-970R+ROS-	830-970	5.0	-80	-107	-128	-148	1	1.5	39-44	-26	-19	80	5.0	35	8	34
ROS-1700-819R+	1690-1740	1.0	-82	-108	-130	-150	0.70	0.20	22	-20	-10	100	5.0	40	8	37
ROS-2488C-119+	2488-2488	8.5	-92	-118	-140	-160	1.5	0.05	4.4	-25	-15	50	5.0	33	6	55
ROS-2566C-119+	2566-2566	8	-94	-121	-141	-161	0.7	0.1	4.3	-27	-17	50	8.0	36	5	42
ROS-39702PH19R+	3790-3970	3.5	-70	-98	-119	-139	6.0	0.6	48-63	-23	-15	180	5.0	37	8	37

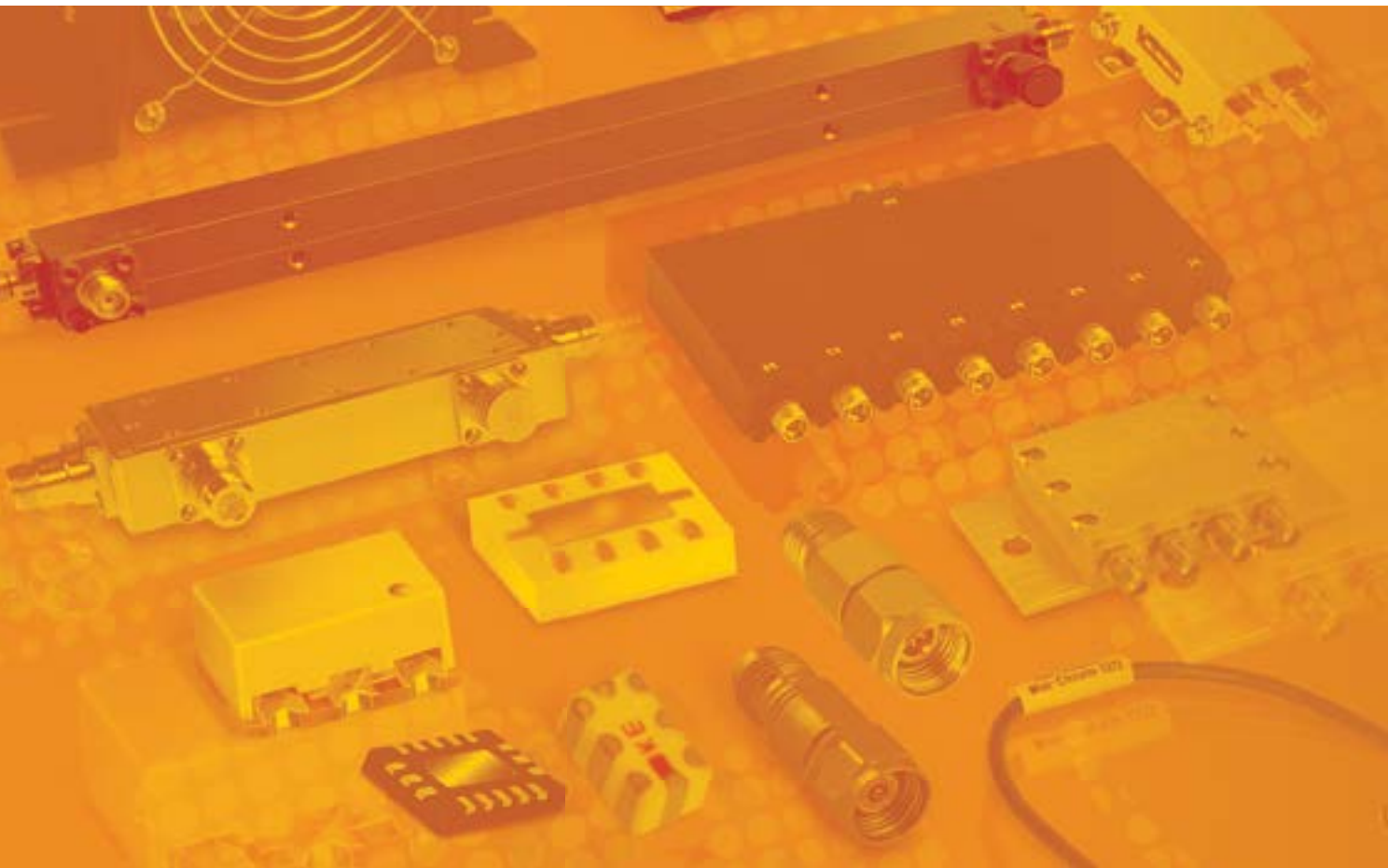

Direct Sales

- › **Brooklyn**
sales@minicircuits.com
1 718-934-4500
- › **Missouri**
sales@minicircuits.com
1 417-335-5935
- › **Europe**
sales@uk.minicircuits.com
44 1252-832600
- › **Taiwan**
robert@min-kai.com.tw
886 3 318 4450

Technical Support

- › **NORTH AMERICA**
apps@minicircuits.com
(718) 934-4500
- › **SINGAPORE, INDONESIA
MALAYSIA, THAILAND**
sales@minicircuits.com.my
(604) 646-2828
- › **ISRAEL**
app@ravon.co.il
972 4 8749100
- › **TAIWAN & PHILIPPINES**
robert@min-kai.com.tw
- › **EUROPE**
apps@uk.minicircuits.com
44 1252 832600
- › **INDIA**
apps@minicircuits.com
91 44 2 2622575
- › **CHINA**
sales@mitron.cn
86 591-8787 0001
Or
yuanzhong@minicircuits.com
86 020-8734 0992